

144MHz ALL MODE TRANSCEIVER

TR-751A/E

SERVICE MANUAL

KENWOOD

TRIO-KENWOOD CORPORATION

©1986-5 PRINTED IN JAPAN
B51-2084-00(O)1501



Photo is TR-751A.

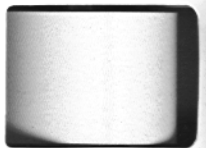

CIRCUIT DESCRIPTION

UNIT \ MODEL	TR-751A (K, M1, M2)	TR-751E (W, T)
FINAL UNIT	X45-1490-11	X45-1490-11
CONTROL UNIT	X53-1460-11 (K, M1) X53-1460-21 (M2)	X53-1460-51 (T) X53-1460-61 (W)
COMPOSITE UNIT (PLL, TX)	X60-1310-11	X60-1310-01
COMPOSITE UNIT (RX)	X60-1320-11	X60-1320-00

Table 1 TR-751A/E PC board chart

FREQUENCY CONFIGURATION

The TR-751A/E utilizes a PLL synthesizer system incorporating a digital VFO, which covers each band in 50Hz steps. (See Fig. 1.)

Received signals are mixed with the first local oscillator (133.305 to 137.295MHz) to produce the first intermediate frequency of 10.695MHz. In SSB or CW, the receiver operates as a single conversion system. The 10.695MHz IF signal is applied to crystal filter XF1 (L71-0249-05), and the signal is then applied to the ring detector to obtain the audio output.

In FM, the receiver operates as a double conversion system. The 10.695MHz signal is mixed with the PLL reference frequency of 10.24MHz to produce the second intermediate frequency of 455kHz.

The transmitter system operates as a double conversion system. In SSB mode, output from the carrier oscillator is modulated by a balanced modulator to produce an intermediate frequency signal, which is then mixed with the first local oscillator signal to produce the two meter transmit signal. The carrier oscillator circuit is controlled by the microprocessor according to the selected mode.

During USB or CW receive, the carrier oscillator frequency is 10.6935MHz. During LSB receive, it is 10.6965 MHz. During CW transmit, it is 10.6943MHz. In FM, a

10.695MHz crystal oscillator frequency is used that is directly modulated and then mixed with the first local oscillator signal.

To minimize internal heterodyne tones and spurs in the frequency generator and analysis are controlled by a microprocessor. The PLL-based frequency system consists of two PLL synthesizer loops controlled by a 4-bit high-speed microprocessor and a stable, analog RIT oscillator circuit.

Item	Rating
Nominal frequency	10.695MHz
Allowable center freq' deviation	Within ± 200 Hz at 6dB
Pass bandwidth and attenuation bandwidth (based on minimum loss)	2.2kHz or more at 6dB Within ± 1.5 kHz at 20dB Within ± 2.4 kHz at 60dB
Ripple	2dB or less
Minimum loss	5dB or less
Guaranteed attenuation	60dB or more within ± 40 kHz
I/O terminating impedance	1.2k Ω $\pm 5\%$ /6pF $\pm 5\%$

Table 2 Crystal filter 10F2.2S (L71-0249-05) characteristics (Composit unit (RX) XF1)

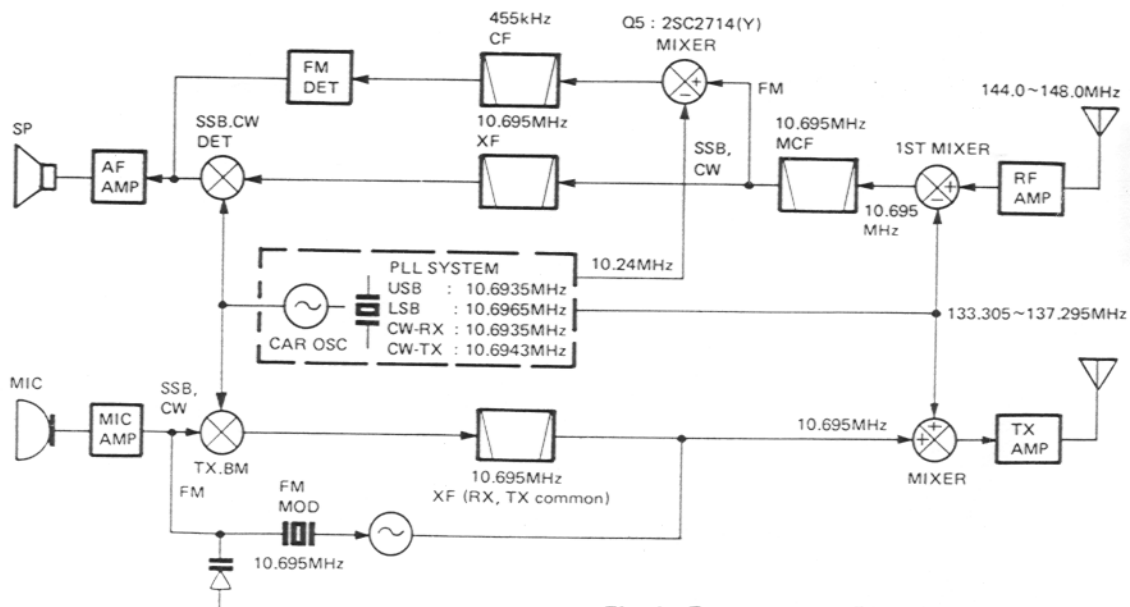

Fig. 1 Frequency configuration

CIRCUIT DESCRIPTION

RECEIVER SYSTEM

• General

Incoming signals from the antenna pass through a low-pass filter in the Transmitter Final unit and a diode switch (D5,D6) for transmit/receive selection. The signals then go through two antenna coils (L201 and L202) and then are amplified by a GaAs FET (Q201). Undesired signals are removed from the RF signal by a 3-pole helical resonator (L203) and the resulting signal is then applied to the first mixer (Q202). The signal is mixed there with the first local oscillator signal from the PLL system to produce the first IF signal of 10.695MHz. Undesirable adjacent channel signals are removed from the first IF signal by a two stage monolithic crystal filter (MCF : XF201).

The first IF signal is then distributed to either the SSB or FM circuits.

In the SSB circuit, the first IF signal goes through noise blanker gate (D1 and D2) then amplified by a Dual Gate MOS FET (Q1) and then applied to the SSB crystal filter (XF1). The filtered signal is then amplified by the 1st IF Amplifier (Q2) and the 2nd IF Amplifier (Q3) and then applied to the ring detector (D5-D8) to obtain the received audio signal.

In the FM circuit, the first IF signal is amplified by a Grounded Gate (Q4) J-FET and applied to the second mixer (Q5). The IF signal is mixed with 10.24MHz to produce the second IF signal of 455kHz. Adjacent channel interference is removed from the second IF signals by FM ceramic filter (CF1), the second IF signal is then amplified and detected by IC2 to obtain the received audio signal.

The audio signal from the SSB and FM circuits is then amplified by a common audio preamplifier Q1 (X59-1110-00). High-frequency components are removed from the audio signal by an active LPF (Q2). The audio signal is then applied to the audio volume control on the front panel. The audio signal is amplified again by audio amplifier IC1 (X60-1310-XX) and then applied to the speaker.

Item	Rating
Nominal center frequency (fo)	10.695MHz
Pass bandwidth	Within ± 7.5 kHz at 3dB
Attenuation bandwidth	Within ± 25 kHz at 40dB Within ± 45 kHz at 60dB
Guaranteed attenuation	70dB or more within ± 1 MHz 40dB or more spurious at $f_o \sim f_o + 500$ kHz 80dB or more spurious at $f_o - (910 \pm 10)$ kHz
Ripple	1.0dB or less
Insertion loss	1.5dB or less
Terminating impedance	3k Ω /0pF

Table 3 10.695MHz MCF (L71-0216-05) characteristics (Composit unit (RX) XF201)

Item	Rating
Nominal center frequency	455kHz ± 1 kHz
6dB bandwidth	Within ± 6 kHz (from 455kHz)
50dB bandwidth	Within ± 12.5 kHz (from 455kHz)
Ripple (within ± 4 kHz from 455kHz)	3dB or less
Insertion loss	6dB or less
Guaranteed attenuation (within ± 100 kHz from 455kHz)	35dB or less
I/O matching impedance	20k Ω

Table 4 Ceramic filter CFW 455F (L71-0315-05) characteristics (Composite unit (RX) CF1)

• Front end and AGC circuit

The performance of any receiver is determined largely by the performance of its front end section. Important factors which determine the performance of a receiver are sensitivity and two signal characteristics. Recently, most single mode receivers have used GaAs FETs to improve their sensitivity, while all-mode receivers used Dual Gate MOS FETs for improved AGC characteristics and RF gain control of their high frequency amplifiers. This was because, even though the AGC line was placed between the high frequency amplifier and intermediate frequency amplifier, the best way to improve the AGC characteristic had been to control the second gate of the dual-gate MOS FET. When GaAs FET's were used, such AGC characteristics had not been obtained even if the second gate was controlled by the same voltage that was used for a Dual Gate MOS FET. Fig. 2 shows the AGC Vs. gain attenuation characteristics obtained from the high frequency amplifier (MOS FET : 3SK76) and GaAs FET : 3SK129 used in a TR-9000G. Since the intermediate frequency amplifier uses a MOS FET : 3SK73, almost no attenuation occurs in the high frequency amplifier even if the AGC voltage is fed directly into the GaAs FET.

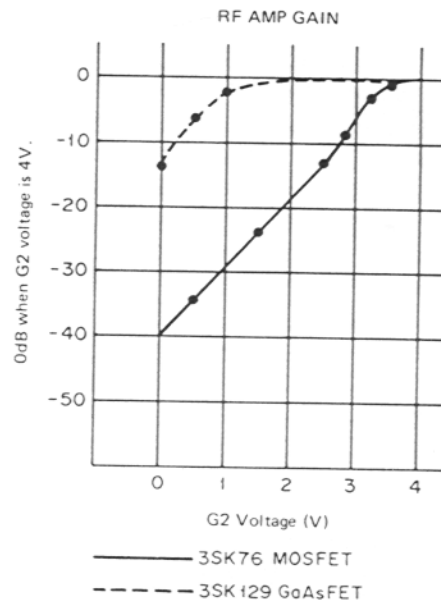

Fig. 2 AGC attenuation comparison

CIRCUIT DESCRIPTION

The TR-751A/E AGC circuit has been designed to allow the AGC voltage to control the GaAs FET similar to the control that was obtained with the MOS FET. As shown in Fig. 3, AGC voltage from an amplifier similar to that used in previous models is fed into the intermediate frequency amplifier. The AGC voltage is approx. 4V when no signal is present. The AGC voltage is amplified by the non-DC current inversion amplifier circuit that is composed of Op Amplifier (IC3). Its output is then applied to the GaAs FET. The output voltage is set to approx. 2.5V when no signal is present, or at minimum RF gain. The AGC characteristics are shown in Fig. 4. The AGC time constant is automatically switched to slow in SSB mode or to fast in CW mode. The high sensitivity of the receiver system is thus obtained without sacrificing any two signal characteristic.

Additionally, the RF gain control, provides a convenient method of tuning out undesired signals even when receiving signals that are too strong from near by local stations.

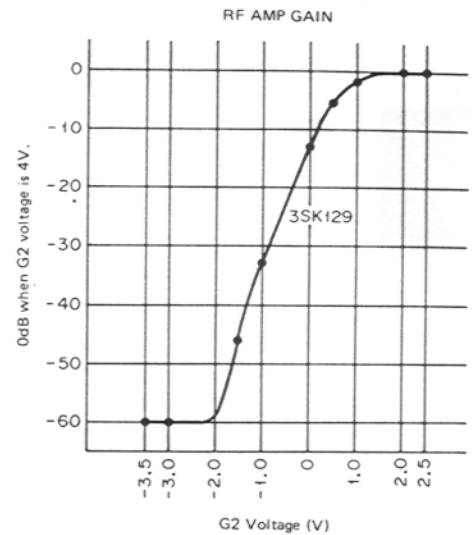

Fig. 4 AGC attenuation comparison

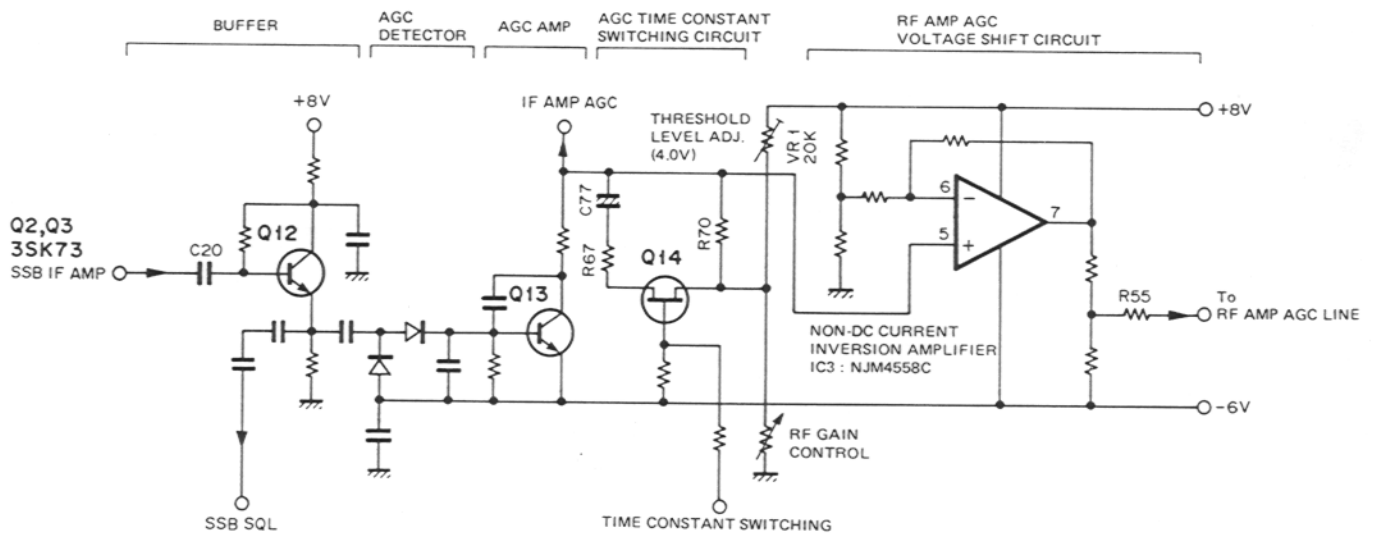

Fig. 3 AGC circuit block diagram

• SSB squelch circuit

The TR-751A/E SSB squelch circuit is a noise operated type squelch. As compared with signal type squelch, noise detection squelch may be opened even by very weak signals, such as are frequently encountered in SSB.

The high sensitivity of the squelch circuit provides advantages when receiving VHF signals from distant stations and when scanning. Generally, signal type squelch cannot surpass noise detection type in sensitivity, since they are opened by changes in the AGC voltage. It means that, to open a signal type squelch, sufficient voltage level of signal to deflect the S meter is required. The sensitivity of the TR-751A/E squelch is $0.1\mu\text{V}$ or less (a weak signal which will not deflect the S meter.)

The squelch signal is applied to IC2 used in FM mode, through the SSB filter, SSB IF, and buffer amplifier. This IC, mixes the signal with 10.24MHz to produce 455kHz. Like the FM IF, the 455kHz signal is also amplified by IC2 and applied to the same squelch circuit as that used in FM mode. Since SSB signals do not contain carrier, unlike FM signals, the time constant circuit is switched between FM mode and SSB mode to get an appropriate response time.

CIRCUIT DESCRIPTION

TRANSMITTER SYSTEM

• General

The transmitter system operates as a single conversion system.

Audio signals from the microphone are amplified by a low-noise transistor (Q25) and applied to the SSB or FM circuits which provide approx. 26dB gain.

In SSB, the amplified signal passes through the SSB microphone gain control, and is amplified by (Q27) and applied to the balanced modulator (IC4). The balanced modulator consists of an IC that provides stable carrier suppression without being influenced by changes in temperature. Signals from the microphone amplifier are mixed with the carrier to produce a DSB signal. The DSB signal is applied to the SSB filter (with a center frequency of 10.695MHz) to produce the SSB signal.

In FM, the signal amplified by the SSB/FM common microphone amplifier (Q25) is applied through the buffer amplifier (Q24) and FM microphone gain control, and then to the pre-emphasis circuit, amplified by (IC1), and limited by Op amplifier (IC1). High frequency components are then removed from the signal by a 18dB/oct splatter filter, and the signal is sent to the FM modulation circuit.

In the FM modulation circuit, signals from the 10.695 MHz crystal oscillator circuit are directly modulated by varactor diode (D21), variable capacitor. This direct frequency modulation enables a flat transmitter frequency response to be obtained from low frequencies to high frequencies. If the frequency deviation becomes excessive, the deviation level will vary from the upper to the lower portion of the signal. The TR-751A/E is designed so that the upper and lower portions of the signal are balanced even with maximum frequency deviation.

SSB/FM switching is performed by diode switching circuit according to the selected mode, and then amplified by the transmitter IF circuit. This IF amplifier circuit consists of a dual-gate MOS FET, whose second gate is provided with ALC voltage to control the transmitter output.

The transmitter IF signal is then mixed with the PLL signal by balanced mixer consisting of two FETs (Q1, Q2) to produce a 144MHz signal. Undesirable components are removed from the signal by a band-pass filter to minimize spurious emission. The signal from the band-pass filter is then amplified twice, once by a dual-gate MOS FET (Q3) and once by transistor (Q4), to raise the signal to the level necessary to drive the Final unit. The TR-751A/E contains an additional transistor amplifier (Q5).

The signal from the drive circuit is amplified by the power module (Q1) in the Final unit, and goes through the ANT switching and diodes (D5, D6) and low-pass filter to remove higher harmonics, and is supplied to the antenna.

• CW circuit description

In CW, the balanced modulator is unbalanced by AGC signal to allow the carrier to pass.

CW keying is performed by switching the balanced mixer in the drive circuit and a bias voltage is applied to the first gate of amplifier. Fig. 5 shows the keying waveform. The leading and trailing edges are smoothed to prevent key clicks.

To facilitate CW communications, the CW circuit contains CW semi break-in and side tone circuits.

The CW semi break-in circuit is a Schmitt circuit consisting of transistors (Q1–Q4) or the break-in sub assembly. The delay time can be adjusted with VR7.

The side tone circuit operates whenever the key is closed. The side tone circuit operates in modes other than CW, so key adjustment and morse code practice can be performed. Transistor (Q9) is used as the oscillator. Signals from the side tone circuit are amplified by the audio amplifier (IC1). The output frequency of approx. 800Hz can be adjusted with potentiometer (VR4).

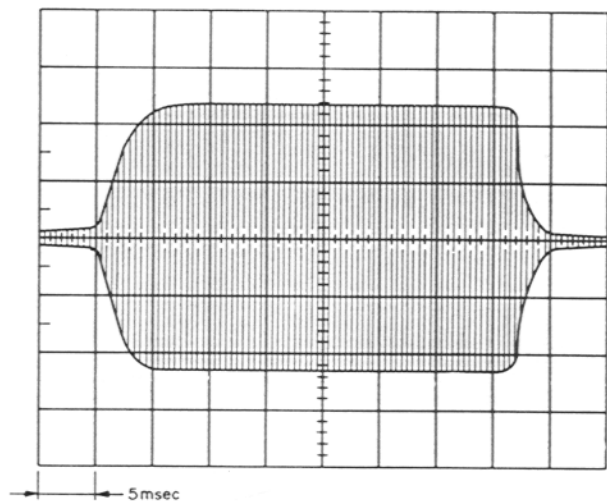

Fig. 5 CW waveform

CIRCUIT DESCRIPTION

• ALC and SWR protection circuits

Fig. 6 shows the basic ALC and SWR protection circuits.

ALC detection is made by amplifying a sample from the power module in the Final unit. The DC output signal is amplified by transistor (Q7) lower the ALC which controls the gain of the IF amplifiers. Low power is selected by controlling the ALC Amplifier (Q7) with transistor (Q8).

If the linearity of the Final is not well balanced with ALC feedback, SSB distortion may occur. The TR-751A/E is designed to minimize SSB distortion.

The SWR protection circuit detects and amplifies any reflected power due to mismatching in the antenna with a CM coupler. Output from the SWR protection circuit lowers the ALC reference voltage to reduce the gain of the power module for protection.

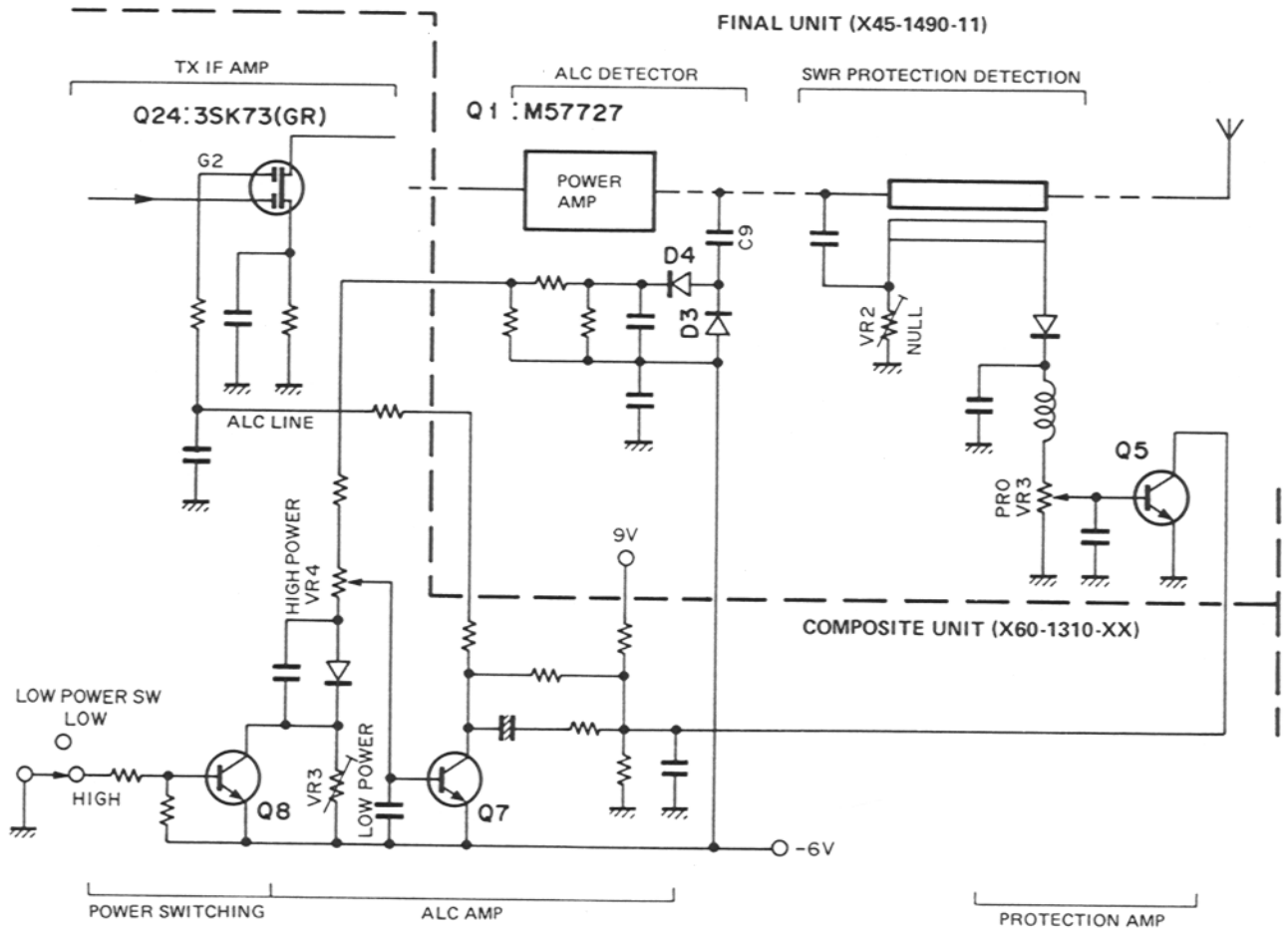

Fig. 6 ALC and SWR protection circuits

CIRCUIT DESCRIPTION

PLL SYNTHESIZER

Fig. 7 is the PLL system block diagram.

The most important feature of the TR-751A/E PLL system is that the main loop VCO (Loop A) is composed of a sub-unit to avoid the unit being influenced by outside forces (especially vibration), which improve the frequency stability. During mobile operation in SSB or CW, this provides a great increase advantage in reliability.

The PLL system uses two loops to form a digital VFO which covers each band in 50Hz steps. Each of the loops uses a PLL IC (TC9172P) with pulse swallow type pre-scaler.

The B loop utilizes a 2.5kHz comparison frequency. The range of its VCO output frequency is from 28 to 27MHz (frequency division ratio 11200 to 10800 : 1). The B loop VCO output is frequency divided by 50 (to produce 560 to 540kHz), which is used to produce a signal that covers 20kHz from 9.68 to 9.70MHz in 50Hz steps. This signal is then mixed with the reference oscillator frequency of 10.24MHz.

The RIT oscillator circuit utilizes a signal of 11.805MHz which is multiplied by nine. The oscillator frequency range can be varied ± 1.2 kHz or more by varying the voltage of the variable capacitor in the oscillator (analog control). When the RIT switch is off, the variable capacitor voltage is fixed, because of high resistance, and the RIT oscillator operates as a stable local frequency oscillator. The RIT ON signal is detected by the microprocessor and transferred to the PLL IC containing which contains an I/O port to control the RIT switching circuit. The RIT oscillator output is mixed with 9.68 to 9.70MHz to produce a frequency range from 115.925 to 115.945MHz for A loop mixing.

The A loop uses a 20kHz comparison frequency to control loop A over a range of IF 17.38 to 19.37MHz to yield a VCO output range frequency from 133.305 to 137.305MHz (frequency division ratio 869 to 1069 : 1). To cover the entire band in 50Hz steps, the VCO output is mixed with local oscillator signals of 115.925 to 115.945 MHz.

As described above, the PLL system reliability is improved by incorporating the VCO A loop as a sub-unit and high density system by using large scale integration.

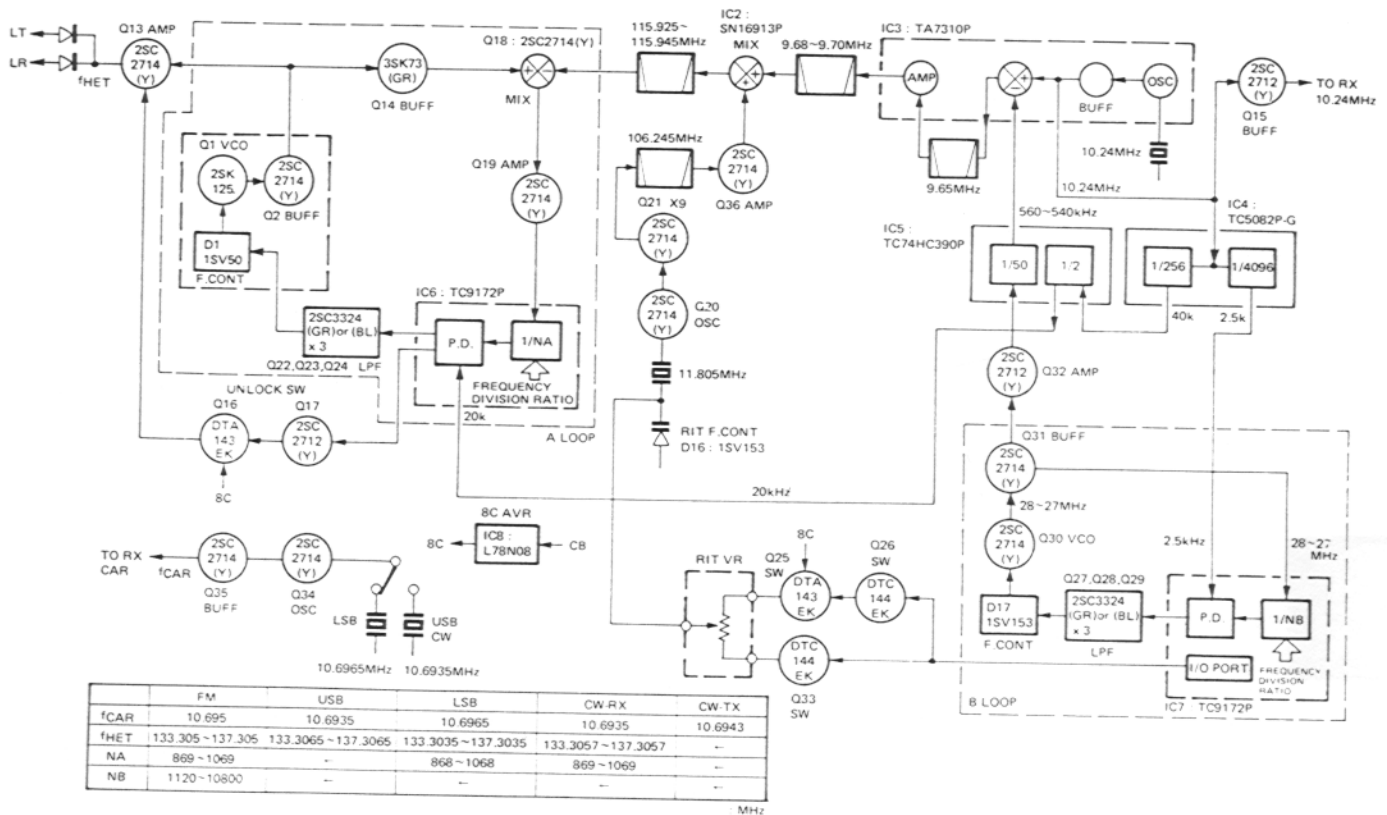

Fig. 7 PLL system block diagram

CIRCUIT DESCRIPTION

DIGITAL CONTROL UNIT

• General

The Control unit consists of two PC boards : one on the front panel and the other on the main chassis. The processing is controlled by three microprocessor (hereafter called the MPUs).

Fig. 8 is the Control unit block diagram. The Control unit includes three MPUs, their interface circuits, an input circuit (consisting of a rotary encoder, keys, and switches), a reset backup circuit, a mode switching circuit, and various other switching circuits.

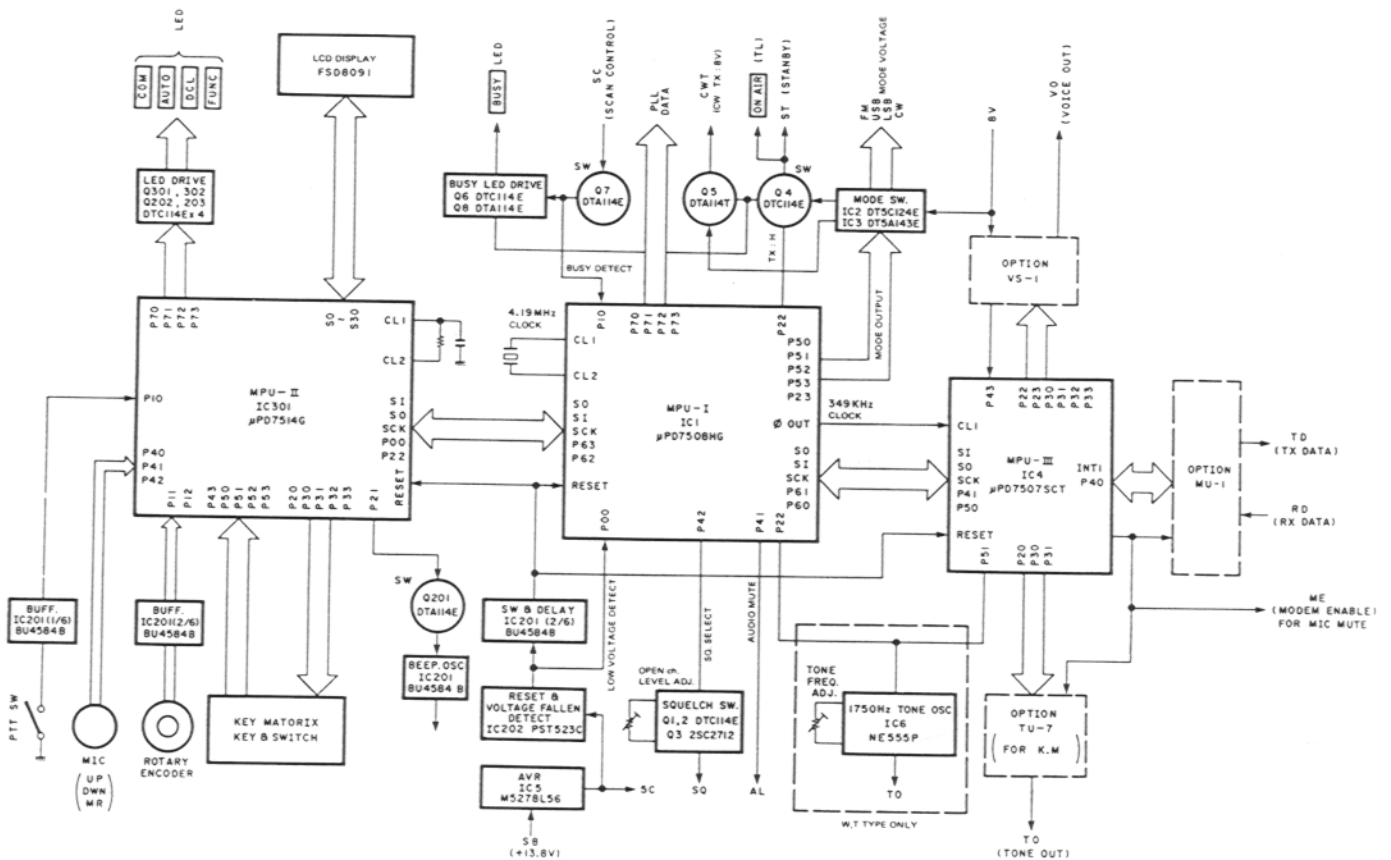

Fig. 8 Control unit block diagram

CIRCUIT DESCRIPTION

- **MPU interface circuits**

Fig. 9 shows how the three MPUs are interfaced. To exchange data between the MPUs, three clock and data I/O lines (SCK, SI and SO) and two each of control lines SCK, SQR, DCK, and DRQ are provided.

- **Reset backup circuit**

Fig. 9 also shows the reset backup circuit. When the transceiver power is turned on, an approx. 20ms H level pulse is sent from the reset circuit using a dedicated reset IC (IC201) to the RES line. Since the RES line is connected to all MPUs (MPU-I, MPU-II, MPU-III), the MPUs begin operation at the same time. When the power is turned off, IC202 recognizes that the voltage of the 5V line fell to 4.5V or less, and sets the low voltage fallen detect line (VFD) to a low level. The VFD signal is sent to MPU-I P00 and MPU enters the backup mode.

Output voltage from the lithium battery for backup is supplied to MPU-I and MPU-II providing backup for two MPUs.

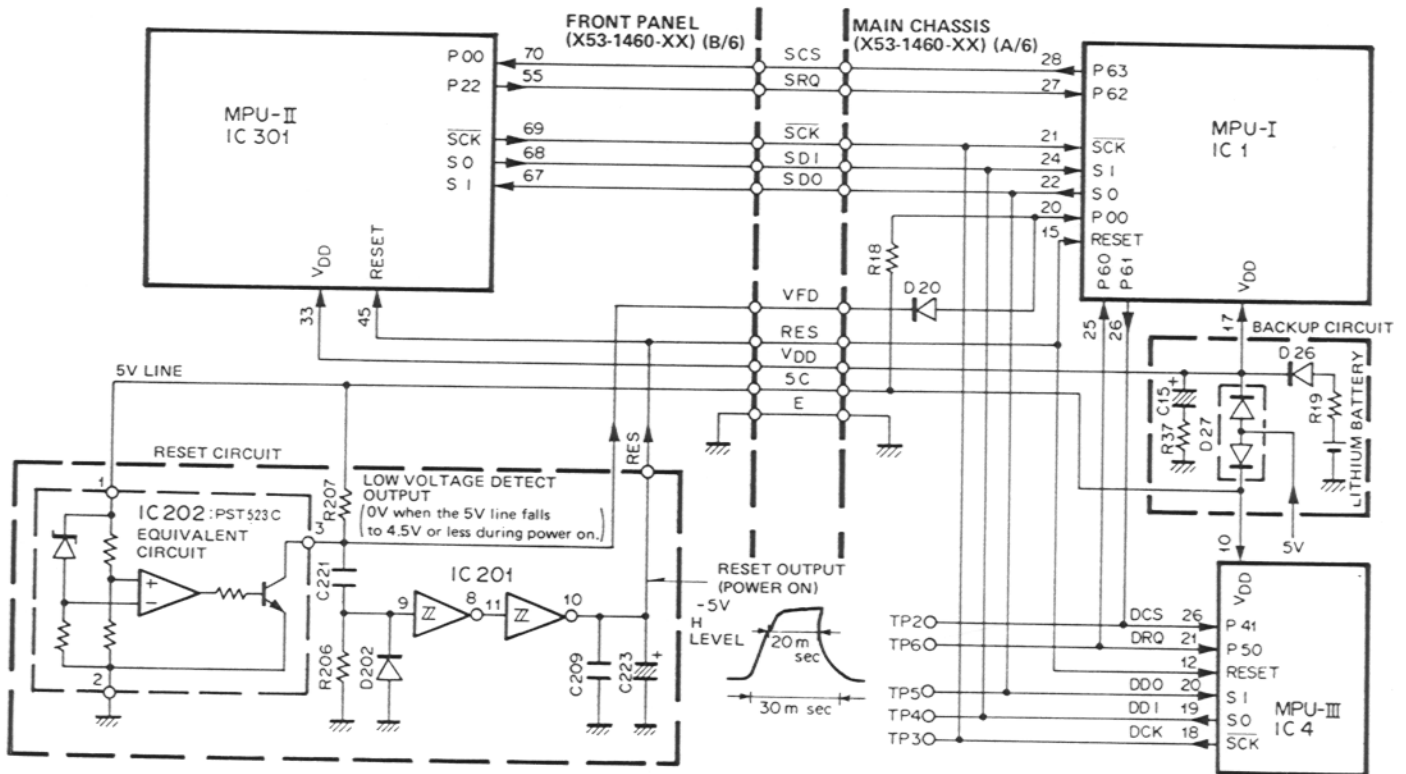

Fig. 9 Intertace between MPUs and reset backup circuit

CIRCUIT DESCRIPTION

● Key, switch and encoder circuits

Fig. 10 shows the key, switch, and encoder input circuits. The front panel keys are arranged in a matrix and key signals are sent to MPU-II, using a key scan technique. The microphone switch lines (PTT, UP, DOWN, etc.) are connected to MPU-II through the protection diodes, CR time constant circuit, and chatter absorption circuits. The encoder is also connected to MPU-II through the CR time constant circuit and the inverter of the Schmitt trigger inputs (IC201) for chattering absorption.

MIC Pin	3	4	6
Port bit	2	1	0
Switch/Port	DWN	UP	MR
UP + DWN	0	0	0
RES	0	0	1
DOWN	0	1	0
CHL	0	1	1
UP	1	0	0
MR	1	0	1
OFF(MC-55)	1	1	0
OFF(MC-56)	1	1	1

Table 5 Microphone input logic

	P53	P52	P51	P50	P43
P20		▼/F. LOCK	▲/AL	COM/TONE	VOICE/TONE
P30				RIT	FUNC.
P31	CS	CSQ	RES	CHL	DCL
P32	1 AUTO	2 FM/LSB	3 USB/CW	4 REV	5 MR
P33	6 F.STEP	7 SCAN	8 M	9 OFFSET	φ A/B

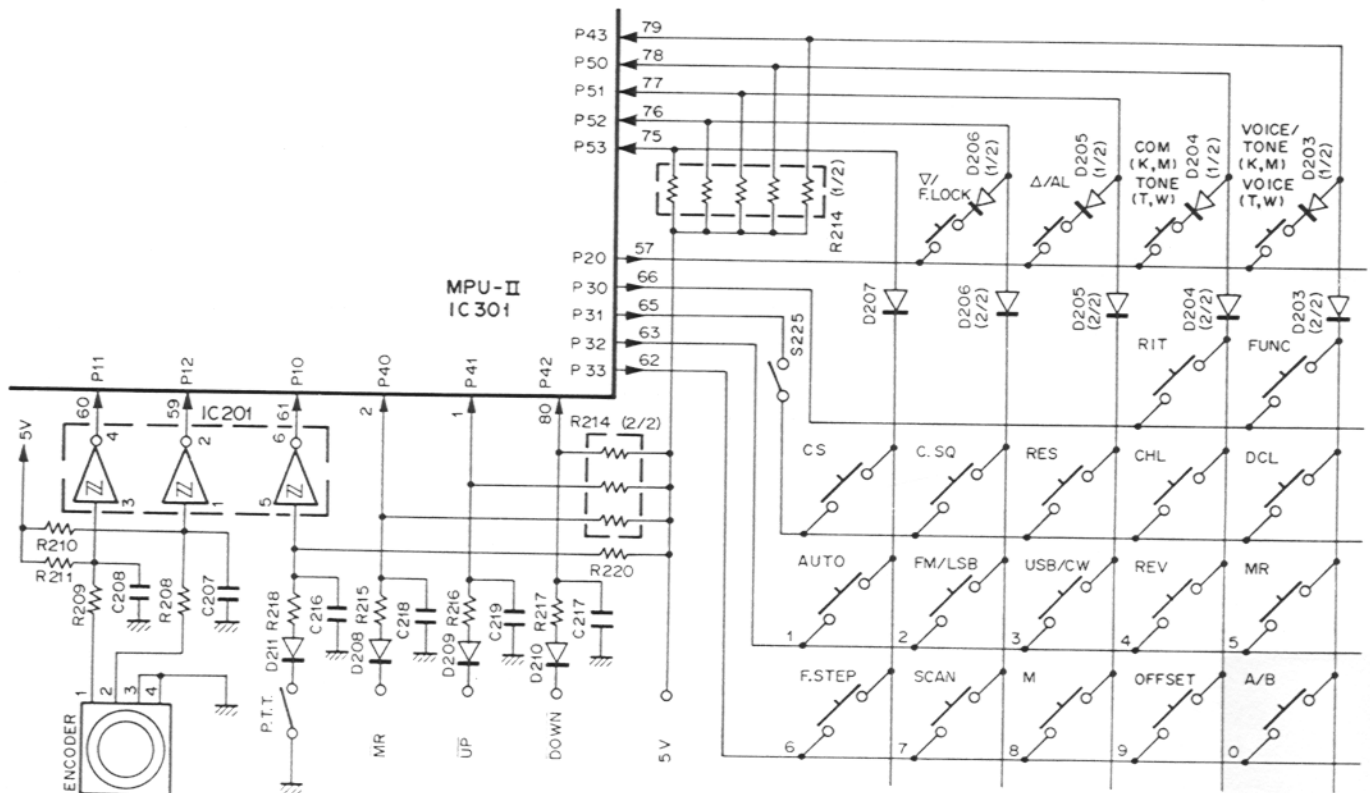

Fig. 10 Key, switch and encoder input circuit

CIRCUIT DESCRIPTION

• Mode voltage switching and standby circuit

Fig. 11 shows the mode voltage switching and standby circuit. When a mode is selected with a front panel key, the corresponding port on MPU-I is set to high (5V) and an appropriate mode voltage is transmitted by switching the 8V line.

When the PTT is pressed, MPU-II sends information to MPU-I, and port P22 of MPU-I is set to H, switching Q4.

• Other I/O circuits

1. Busy input circuit

The Busy input circuit is used to determine whether the scan or DCL system has received a signal. The squelch signal from the receiver system is switched by Q7 and applied to port P10 of MPU-I. This signal also turns the BUSY indicator on, using Q6 and Q8 for switching.

2. Squelch switching circuit

The squelch switching circuit is used to switch between the squelch control on the panel and internal VR1 (Q1-Q3). Usually, Q3 is on to enable the squelch control on the panel. When the DCL system searches for an open channel, Q1 and Q2 are switched on, and Q3 is turned off by signals from port P42 of MPU-I to enable internal trimmer VR1.

3. Audio mute output (AL)

When checking memory channel M1, performing code squelch, or searching for an open channel during alert operations, port P41 of MPU-I is set to H (5V) to mute audio output.

4. Microphone mute output (ME)

The ME signal is used to mute audio inputs from the microphone when the DCL system transmits a control signal. Port P53 of MPU-III is set to H (5V) to switch Q26 in the MIC input of the RX unit. This signal is also used to control a modem IC in the modem unit MU-1.

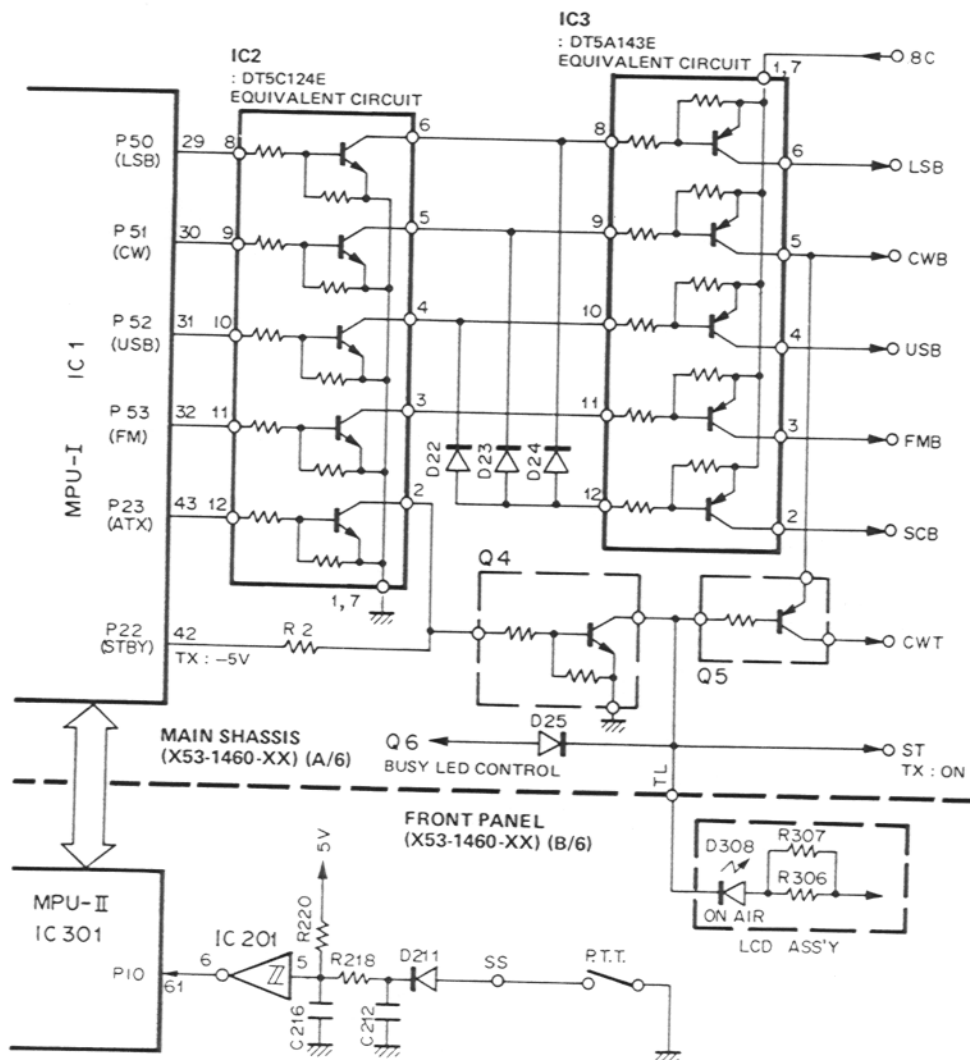

Fig. 11 MODE voltage switching and standby circuit

CIRCUIT DESCRIPTION

Test points

TP2	DCS	DCL Chip Select	Data line between MPU-I and MPU-II. Temporarily set to H when an MU-1 or VS-1 related operation is performed. If this line is not reset to L, MPU-III or its peripheral circuit is bad.
TP6	DRQ	DCL Request	
TP7	VFD	Voltage Fallen Detect	Detects a voltage drop in the 5V line. The voltage of this line is 5V when power is on, and 0V when power is off, or when the 5V line falls to 4.5V or less. When the voltage of this line is abnormal, the VFD line is broken, or IC201 or IC202 is faulty.
TP8			Used to monitor the your own DCL control signal through the internal speaker. To monitor it, connect this pin to TP201. Connect only when CD-10 is used.

Microprocessor clock

IC1	ϕ OUT	39 pin	Sends the 349kHz produced by frequency dividing X1 (4.19MHz) by 12. This clock is supplied to CL1 of MPU-III (IC4) through C12.
IC4	CL1	13 pin	Clock input for the above pin. The 349kHz square wave can be monitored at this pin.

Connectors

J5	VFD	Voltage Fallen Detect	Same function as TP7 above.
	VDD	Microprocessor backup voltage	Power line between MPU-I (IC1) and MPU-III (IC4). Backed up by a lithium battery when the transceiver power is off. Set to 5V when power is on, 2.5V when power is off. When the voltage drops, the battery is exhausted, or its peripheral circuit (D26 or C15) is faulty.
	RES	Reset	Reset line between MPU-I, MPU-II, and MPU-III. Supplies a 5V peak wave for approx. 20ms when power is turned on.
	SCS	Slave Chip Select	Data line between MPU-I and MPU-II. Temporarily set to H when a front panel operation is made.
	SRQ	Slave Request	When this line is not reset to L, the SCS, SRQ, SCK, SDI, or SDO line is broken, or the LCD assembly may be faulty.

Table 6 Test pins

Pin No.	Name	I/O	Function	Logic	Pin No.	Name	I/O	Function	Logic
1	P10	I	BUSY input (H : Busy, L : Open)		23	NC	-	Not used	
2	P11	I	D17 detect input		24	SI	I	Serial data input	
3	P12	I	D16 detect input		25	P60	O	DCL request (DRQ) (to IC4)	
4	P13	-	Not used (NC)		26	P61	O	DCL chip select (DCS) (to IC4)	
5	P30	-	Not used (NC)		27	P62	O	Slave request (SRQ) (to IC301)	
6	P31	O	Output for D16/D17 detection		28	P63	O	Slave chip select (SCS) (to IC301)	
7	P32	O	Tone control output 1750Hz (for W)		29	P50	O	LSB mode select output (in LSB : H)	
8	P33	-	Not used (NC)		30	P51	O	CW mode select output (in CW : H)	
9	P70	O	PLL serial data		31	P52	O	USB mode select output (in USB : H)	
10	P71	O	PLL serial clock		32	P53	O	FM model select output (in FM : H)	
11	NC	-	Not used		33	P40	-	Not used (NC)	
12	NC	-	Not used		34	P41	O	Audio mute output (in Alert search : H)	
13	P72	O	PLL A loop enable		35	P42	O	SQ select output (in open search : H)	
14	P73	O	PLL B loop enable		36	P43	-	Not used (NC)	
15	RESET	I	Reset input		37	Vss	-	GND	
16	CL1	-	Connect to oscillator		38	EVENT	-	Not used (GND)	
17	VDD	-	Power pin (5V)		39	ϕ OUT	O	349kHz output (To IC4)	
18	CL1	-	Connect to oscillator		40	P20	O	Output for switching diode	
19	INT 1	-	Not used (GND)		41	P21	O	Output for switching diode	
20	P00	I	Low voltage detect input (VFD)		42	P22	O	Transmit select (transmit mode : H)	
21	SCK	I	Serial clock input (SCK, DCK)		43	P23	O	Transmit disable	
22	SO	O	Serial data output (SDO, DDO)		44	NC	-	Not used	

SQ = Squelch

Table 7 μ PD7508HG-545-22 (MPU-I) pin functions (Control unit IC1)

CIRCUIT DESCRIPTION

Pin No.	Name	I/O	Function	Logic	Pin No.	Name	I/O	Function	Logic
1	P43	I	Option VS-1 BUSY input		15	CL2	-	Not used (NC)	
2	X1	-	Not used		16	INT1	I	Model clock input (from MU-1)	
3	X2	-	Not used		17	INT0	-	Not used (GND)	
4	P20	O	Option TU-7 latch output (for K, M)		18	SCK	O	Serial clock (DCK)	
5	P21	-	Not used		19	SO	O	Serial data output (DDI)	
6	P22	O	Option VS-1 strobe output (SR)		20	SI	I	Serial data input (DDO)	
7	P23	O	PS4 Option VS-1 data output		21	P50	O	DCL request (DRQ) (to MU-1)	
8	P30	O	PS3 VS-1/TU-7 clock, data output		22	P51	-	Option TU-7 clock output (for W, T)	
9	P31	O	PS2 VS-1/TU-7 clock output		23	P52	-	Not used (NC)	
10	P32	O	PS1 Option VS-1 data output		24	P53	O	Modem enable output (to MU-1)	
11	P33	O	PS0 Option VS-1 data output		25	P40	I/O	Model data input and output (to MU-1)	
12	RESET	I	Reset input		26	P41	I	DCL chip select (DCS) (from IC1)	
13	CL1	I	349kHz clock input (from IC1)		27	P42	-	Not used (NC)	
14	VDD	-	Power pin (5V)		28	Vss	-	GND	

Table 8 μ PD7507SCT-215 (MPU-III) pin functions (Control unit IC4)

Pin No.	Name	I/O	Function	Logic	Pin No.	Name	I/O	Function	Logic	
1	P41	I	Microphone switch input		41	S4	O	Segment display output		
2	P40	I	Microphone switch output		42	NC	-	Not used		
3	X2	-	Not used (NC)		43	S3	O	Segment display output		
4	X1	-	Not used (GND)		44	S4	O			
5	VLC3	-	LCD binary voltage pin		45	S1	O			
6	VLC2	-			46	S0	O			
7	VLC1	-			47	INT1	-	Not used (GND)		
8	COM3	-	Not used (NC)		48	RESET	I	Reset input		
9	COM2	-	Not used (NC)		49	CL1	-	Connect to CR for clock oscillator		
10	COM1	O	LCD common display output		50	CL2	-	Connect to CR for clock oscillator		
11	COM0	O			51	P73	-	Not used (NC)		
12	S31	O		Not used (NC)		52	P72	O	DCL LED display output	
13	S30	O	LCD segment display output		53	P71	O	AUTO LED display output		
14	S29	O			54	P70	O	CALL LED display output		
15	S28	O			55	P22	O	Slave request (SRQ) (to IC1)		
16	S27	O			56	P21	O	Beep output (on : H)		
17	S26	O			57	P20	O	Key scan output		
18	S25	O			58	P13	-	Not used (GND)		
19	S24	O			59	P12	I	Encoder input		
20	S23	O			60	P11	I	Encoder input		
21	S22	O			61	P10	I	PTT switch input		
22	S21	O			62	P33	O	Key scan output		
23	NC	-	Not used		63	P32	O	Key scan output		
24	S20	O	LCD segment display output		64	Vss	-	GND		
25	S19	O			65	P31	O	Key scan output		
26	S18	O			66	P30	O	Key scan output		
27	S17	O			67	SI	I	Serial data input (SDO)		
28	S16	O			68	SO	O	Serial data output (SDI)		
29	S15	O			69	SCK	O	Serial clock		
30	S14	O			70	P00	I	Slave chip select (SCS) (from IC1)		
31	S13	O			71	P63	-	Not used (GND)		
32	S12	O			72	P62	-	Not used (GND)		
33	VDD	-		Power pin (5V)		73	P61	O	FUNC LED output	
34	S11	O	Segment display output		74	P60	O	LCD bias control (Nor...L, Power off : H)		
35	S10	O			75	P53	I	Key scan input		
36	S9	O			76	P52	I			
37	S8	O			77	P51	I			
38	S7	O			78	P50	I			
39	S6	O			79	P43	I			
40	S5	O			80	P42	I	Microphone switch input		

Nor. = Normal

Table 9 μ PD7514G-143-12 (MPU-II) pin functions (LCD assembly IC301)

ELEMENT FUNCTIONS

Final unit (X45-1490-11)

Element	Function	Description
Q1	Power amplifier	
Q2	Drive + B AVR	Approx. 11.5V. When DB voltage is low, Q2, not Q3 or Q4, will be faulty. Could be due to a loose screw or circuit board which would result in poor ground.
Q3,Q4	Drive + B AVR	
Q5	SWR protection control	Adjustable with VR3. Normally, base voltage is 0V and collector voltage is 4.0V in TX mode. When the antenna is opened, base voltage is 0.7V and collector voltage is 1.7V.
D1	Protection against reverse power connection	A short-circuit occurs when DC power connection is reversed. If power is not turned on when correct DC power connection is made, it may be due to a burned negative DC cable.
D2	AVR temperature compensation for drive circuit	
D3,D4	ALC detection	ALC, the RF output coupled with C9 in the Final unit, is rectified by D3 and D4, and supplied as a DC control voltage to the preceding circuitry.
D5,D6	Transmit/receive select	Transmit mode : On. If DC source current flows, and no transmitter output is present, either of the diodes may be faulty.
D7	RF meter detection	Adjustable with VR1. The RF meter reads 8 at 12W/27W.
D8	Reflected wave detection	Adjustable with VR3. 2.5A/3.5A flows when the antenna is short-circuited.

Control unit (X53-1460-XX)

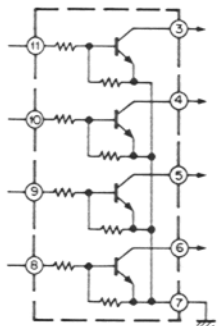
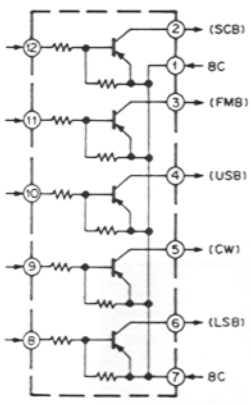
Element	Function	Description
IC1	Microprocessor I	See Circuit Description.
IC2	Mode + B switching	<p>FM mode : ③ LOW, ⑪ HI USB mode : ④ LOW, ⑩ HI CW mode : ⑤ LOW, ⑨ HI LSB mode : ⑥ LOW, ⑧ HI</p> <p>When a mode is selected with a front panel key, a port (P50 to P53) corresponding to the MPU-I PC board is set to H (5V).</p> 
IC3	Mode + B switching	<p>USB, CW, LSB mode : ② + 8V, ⑫ LOW FM mode : ③ + 8V, ⑪ LOW USB mode : ④ + 8V, ⑩ LOW CW mode : ⑤ + 8V, ⑨ LOW LSB mode : ⑥ + 8V, ⑧ LOW</p> 
IC4	Microprocessor II	See Circuit Description.
IC5	5.6V AVR	

ELEMENT FUNCTIONS

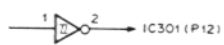
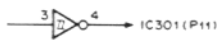
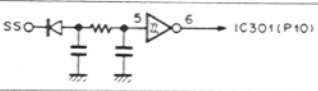
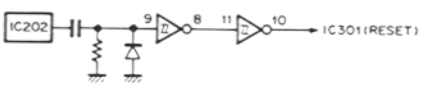
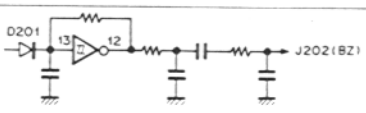
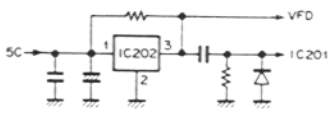
Element	Function	Description
Q1	Open channel search, squelch switching	Normal : Off, search in progress : On. The open channel search level is adjusted with VR1.
Q2	Squelch select	Normal : Off, search in progress : On.
Q3	Panel squelch switching	Normal : Off, search in progress : On.
Q4	Standby switching	Transmit mode : On. The power circuit is switched.
Q5	CW transmit + B switching	CW transmit mode : On.
Q6	BUSY LED switching	Q7 On : On, Q7 Off : Off.
Q7	Scan switching	SC High : Off, SC Low : On.
Q8	BUSY LED switching	Q6 On : On, Q6 Off : Off.
D17,D18	Microprocessor port protection	
D19	Current reversal prevention	USB + LSB = SSB.
D20,D21	Microprocessor port protection	
D22	Current reversal prevention	USB mode : On. IC3 ② outputs + 8V.
D23	Current reversal prevention	CW mode : On. IC3 ② outputs + 8V.
D24	Current reversal prevention	LSB mode : On. IC3 ② outputs + 8V.
D25	Current reversal prevention	Prevents current reversal from the RX.
D26	Current reversal prevention	Prevents current from flowing to the backup battery.
D27	Current reversal prevention	Prevents backup battery current from flowing to inappropriate circuits.
D29	Microprocessor port protection	
IC201 (1/6)	Encoder rectification	Chatter absorption. 
IC201 (2/6)	Encoder rectification	Chatter absorption. 
IC201 (3/6)	Standby rectification	Chatter absorption. 
IC201 (4/6),(5/6)	Reset pulse rectification	
IC201 (6/6)	Beeper oscillation	Approx. 1.9kHz 
IC202	Reset pulse generation	When the transceiver power is turned on, the reset circuit IC202 emits an approx. 20ms high level pulse via the RES line. 
Q201	Beeper switching	Beeper On : Off, normal : On.
Q202	DCL LED switching	DCL On : On.
Q203	FUNC LED switching	FUNC LED On : On.
D201	Current reversal prevention	
D202	Protection against negative voltage	Negative pulse absorption.
D203-D207	Current reversal prevention	Protection against key scan pulse.
D208-D211	For protection	Protection against current from the microphone pins.
D212	FUNC LED	FUNC On : On.
D213	DCL LED	DCL On : On.

ELEMENT FUNCTIONS

LCD assembly (W02-037X-05)

Element	Function	Description
IC301	Microprocessor III	See Circuit Description.
Q301	CALL LED switching	Call mode : On.
Q302	AUTO LED switching	AUTO mode : On.
D301	CALL LED	CALL mode : On.
D302	AUTO LED	AUTO mode : On.
D303	LSB LED	LSB mode : On.
D304	CW LED	CW mode : On.
D305	USB LED	USB mode : On.
D306	FM LED	FM mode : On.
D307	BUSY LED	BUSY mode : On.
D308	ON AIR LED	Transmit mode : On.

Composite unit (PLL, TX) (X60-1310-XX)

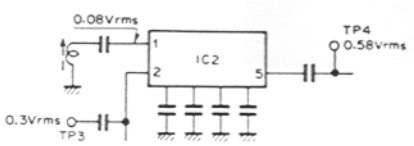
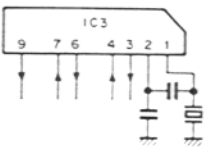
Element	Function	Description
IC1	Audio power amplifier	① output, ⑥ input.
Q1,Q2	Transmit mixer	Operates in the transmit mode. These elements are balanced with VR1 to minimize spurious at $f \pm 10.695\text{MHz}$. 
Q3	Transmit amplifier	Operates in the transmit mode.
Q4	Transmit pre-driver	Observe normal CMOS circuitry precautions when checking this signal.
Q5	Transmit driver	
Q7	ALC amplification	Amplifies signals from the Final unit.
Q8	Transmit output select	High : On, Low : Off, VR3 : Low power adjustment, VR4 : High power adjustment.
Q9	Side tone oscillation	Approx. 800Hz. Adjust to 0.5V/8Ω with VR3 (with the AF centered.)
Q10	Key detect switch	No key : Off, key in CW mode : On.
Q11	Key detect switch	Q10 Off : On, Q10 On : Off.
Q12	Transmit switch	Q11 On or key down : On, Q11 Off or key up : Off.
D1-5	Variable capacitor tuning (VCT)	
D6	For Q5 idling	
D9	ALC circuit temperature compensation	
D10	Side tone circuit temperature compensation	
D11	Side tone switching	Key down : On.
D12,D13	Current reversal prevention	
IC2	Mixer	① 115.925 to 115.945MHz output. ② 106.245MHz input. ⑤ 9.68 to 9.7MHz input. 
IC3	10.24MHz oscillator, amplification, mixer	③ 10.24MHz output. The crystal oscillator (L77-0720-05) is faulty when no signal is at this pin. ④ Mixer input (560 to 540kHz) ⑥ Mixer output (9.68 to 9.7MHz) ⑦ Amplifier input (9.68 to 9.7MHz) ⑨ Amplifier output (9.68 to 9.7MHz) 

ELEMENT FUNCTIONS

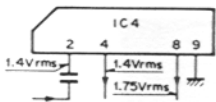
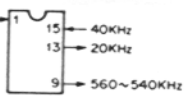
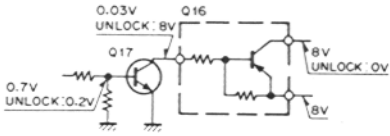
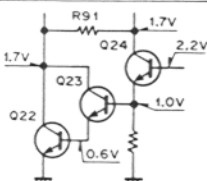
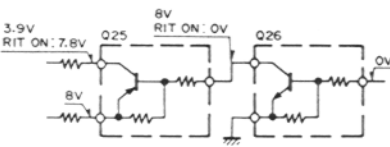
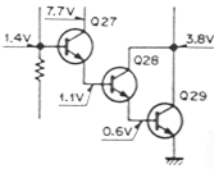
Element	Function	Description
IC4	Frequency divider 1/256, 1/4096	② input (10.24MHz) ④ 2.5kHz output ⑧ 40kHz output 
IC5	Frequency divider 1/2, 1/50	① 28 to 27MHz input ⑨ 560 to 540kHz output } Approx. 1.65Vrms. ⑬ 20kHz output ⑮ 40kHz input 
IC6	PLL	Loop A. ⑩ : unlock detection. Normal : 2.8V, unlocked : 0.3V.
IC7	PLL	Loop B.
IC8	8V AVR	Input : 13.2V (CB line), output : 8.1V
Q13	Output amplifier	Adjustable with TC3. 133.305 to 137.305MHz. Approx. 0.47Vrms at f = 144.00MHz.
Q14	Buffer amplifier	G1 : 0.3Vrms, D : 1.7Vrms.
Q15	Output amplifier	10.24MHz. TP5 : approx. 0.4Vrms.
Q16,Q17	Unlock switching	Locked : On, unlocked : Off. 
Q18,Q19	Loop A PLL IF amplifier	7.38 to 9.36MHz (A loop PLL IF).
Q20	RIT crystal oscillator	11.805MHz
Q21	9 frequency multiplication	106.245MHz.
Q22-Q24	Loop A PLL low-pass filter	
Q25,Q26	RIT switching	RIT Off : Off, RIT On : On. 
Q27-Q29	Loop B PLL low-pass filter	
Q30	B loop VCO	28-27MHz.
Q31	Buffer amplifier	28-27MHz.
Q32	Amplifier	28-27MHz output , 1.0Vrms.
Q33	RIT switching	RIT Off : Off, RIT On : On.
Q34	Carrier oscillator	Operates in SSB or CW mode.
Q35	Buffer amplifier	Operates in SSB or CW mode. J12 CAR pin : 0.3Vrms.
Q36	Amplifier	106.245MHz.
D14	Output switching	Receive mode : On
D15	Output switching	Transmit mode : On. 5.0V is supplied from the RX unit in receive mode (0V in transmit mode.)

ELEMENT FUNCTIONS

Element	Function	Description
D16	For varying RIT	Variable capacitor 1SV153.
D17	For Loop B VCO	Variable capacitor 1SV153.
D18	Carrier crystal switching	LSB mode : On.
D19	Carrier crystal switching	CW transmit mode : On.
D20	Carrier crystal switching	CW receive or USB mode : On.

CW break-in (X59-1130-00)

Element	Function	Description
Q1	KEY DOWN detection	KEY DOWN in CW mode : On.
Q2	Schmitt trigger circuit	KEY DOWN in CW mode : On.
Q3	Schmitt trigger circuit	KEY DOWN in CW mode : Off.
Q4	Transmit switching	KEY DOWN in CW mode : On, information to microprocessors.

Composite unit (RX) (X60-1320-XX)

Element	Function	Description
IC1	Noise amplifier for noise blanker	Amplifies 455kHz in SSB or CW mode.
IC2	FM 455kHz IF amplification and detection Squelch noise amplifier SSB squelch mixer	⑦ FM S meter output, ⑨ Detector output ⑬ Noise amplifier output ⑯ SSB IF signal input.
IC3 (1/2)	FM S meter inversion amplifier	Use VR5 to set the S meter to 0dBμ (antenna input), VR6 to set the S meter to full scale.
IC3 (2/2)	Non-inversion amplifier for RF AGC	Sets AGC voltage to approx. 2.5V at maximum RF gain settings and to approx. -3.5V at minimum RF gain settings.
IC4	For SSB balanced modulator	Carrier suppression is controlled with VR8 and VR9. ① Microphone amplifier input in SSB mode. Carrier is obtained by adding DC current to unbalance the element in the CW mode. ③ Carrier input : 10.695MHz, 0.3Vrms. ⑦ 10.695MHz DSB or CW output
IC5	8V AVR	Input : 13.2V, output : 8.1V.
Q1	SSB first IF amplifier (level 1)	Operates in SSB or CW receive mode (10.695MHz).
Q2	SSB first IF amplifier (level 2)	Operates in SSB or CW receive mode (10.695MHz).
Q3	SSB first IF amplifier (level 3)	Operates in SSB or CW receive mode (10.695MHz).
Q4	FM first IF amplifier	Operates in receive mode (10.695MHz).
Q5	FM second mixer	Operates in receive mode. 10.24MHz is used to produce 455kHz.
Q6	FM receive + B switching	FM receive mode : On.
Q7	FM receive + B switching	SSB or CW mode : On.
Q8	Noise blanker AGC	Controls IC1 gain with NB AGC in SSB or CW mode.
Q9	Noise blanker switching	Switches NB gate when NB is on. Connector : 3.5V (FM). Turns on when pulse noise is present.
Q10	SSB/CW receive + B switching	SSB/CW mode : On.
Q11	SSB/CW receive + B switching	SSB/CW mode : On.
Q12	AGC buffer amplifier	Operates in SSB or CW mode (10.695MHz).
Q13	AGC amplifier	Operates in SSB or CW mode (10.695MHz). AGC is amplified after being rectified by D10 and D11.
Q14	AGC time constant switching	SSB mode : On.
Q15	SSB S meter amplifier	Use VR3 for S meter zero adjustment (S-φ).
Q16	SSB S meter amplifier	Use VR4 for S meter sensitivity adjustment (S-9) : 20dB
Q17	S meter switching	SSB or CW receive mode : On (base voltage in SSB or CW mode : 7.6V). Sets FM S meter amplifier output to 0V.

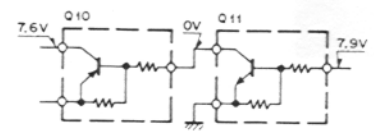
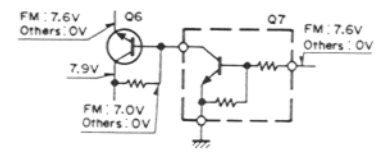

ELEMENT FUNCTIONS

Element	Function	Description
Q18	For FM transmit modulation	Operates in FM transmit mode (10.695MHz). 10.695MHz output from the crystal oscillator is frequency modulated with a variable capacitor.
Q19	Buffer amplifier for FM transmit modulation	Operates in FM transmit mode (10.695MHz).
Q20	FM transmit + B switching	FM transmit mode : On.
Q21	FM transmit + B switching	SSB/CW mode : On.
Q22	SSB/CW transmit + B switching	SSB/CW transmit : On.
Q23	SSB/CW transmit + B switching	Transmit mode : On.
Q24	Transmit IF amplifier	Transmit mode : On (10.695MHz).
Q25	Microphone amplifier (level 1)	Amplifier used in all modes.
Q26	FM buffer amplifier	Use VR12 for FM microphone gain adjustment.
Q27	SSB microphone amplifier	Use VR11 for SSB microphone gain adjustment.
Q28	Microphone amplifier mute switch	Turns on when a DCL control signal is sent.
Q29	Receive + B switching	Transmit mode : Off.
Q30	Receive + B switching	Receive mode : On.
Q31-Q33	Transmit + 9V AVR control	Operates in transmit mode. Set 9V with VR13 in transmit mode.
Q34	Amplifier for illumination + B AVR	Approx. 10.5V
Q35	Detector output switching	SSB or CW mode : On (base voltage in SSB or CW mode : 7.9V). FM detector output is set to 0V in SSB or CW mode.
Q36	Receive audio amplifier mute	Alert on and M1 search in progress in transmit mode : On. Audio output is set to 0V.
D1	Noise blanker gate	Normal : On, NB on for noise suppression : Off.
D2	Noise blanker gate	Normal : On, NB on for noise suppression : Off, Anode in SSB or CW mode : 2.9V.
D3,D4	Crystal filter switch	Switched between SSB/CW receive mode and SSB/CW transmit mode.
D5-D8	Ring detection	
D9	Current reversal prevention	
D10,D11	AGC rectification	
D12	Protection FM S meter reverse deflection	
D13	FMS meter deflection prevention in transmit mode	Operation amplifier output is forced negative in FM transmit + 8V mode.
D14	455kHz IF amplifier input switching	SSB/CW receive mode : On.
D15	Current reversal prevention	
D16	Second mixer output switching	SSB/CW receive mode : On.
D17	Second mixer output switching	FM receive mode : On.
D18	Current reversal prevention	FM receive mode : On.
D19	Noise rectifier for noise blanker	
D20	Noise blanker switching	
D21	For FM modulation	
D22	Transmit IF amplifier input switching	Switched between SSB/CW transmit mode and FM transmit mode.
D23	Current reversal prevention	
D24,D25	Carrier switching	SSB/CW transmit mode : On.
D26	Balanced modulator output switching	SSB/CW transmit mode : On.
D27	Transmit + 9V AVR temperature compensation	
D28	Current reversal prevention	
D29	For lamp AVR reference voltage	
D30	For -6V stabilization	
D31	Current reversal prevention	
D32	Squelch noise rectifier	
D33,D34	Current reversal prevention	
Q201	RF amplifier	3SK129 (Q,R)
Q202	First mixer	3SK74(L)

ELEMENT FUNCTIONS

FM microphone amplifier (X59-1090-00) S/No. 705-707XXXX : W,T

Element	Function	Description
IC1 (1/2)	Low-pass filter	①, ② : output.
IC1 (2/2)	Limiting amplifier	⑥ input, ⑦ output.

-6V DC-DC (X59-1100-00)

Element	Function	Description
Q1	Multi-vibrator	Supplies approx. 19kHz square wave.
Q2	Multi-vibrator	
D1	Voltage multiplying current	

AF preamplifier (X59-1110-00)

Element	Function	Description
Q1	Preamplifier	Squelch On : On.
Q2	Low-pass filter	

Squelch switch (X59-1120-00)

Element	Function	Description
Q1	Squelch switching	Squelch On : On.
Q2	Squelch time constant switching	
Q3	Squelch switching	Squelch On : On.
D1	Base bias setting	
D2	Current reversal prevention	Reversal prevention in SSB and CW modes.

FM microphone amplifier (X59-3000-00) S/No. 705-707XXXX : K,M1,M2

FM microphone amplifier (X59-3000-01) S/No. 708XXXX- : K,M1,M2,W,T

Element	Function	Description
IC1 (1/2)	Low-pass filter	①, ② : output.
IC1 (2/2)	Limiting amplifier	⑥ input, ⑦ output.
Q1	Tone amplifier	

PARTS LIST

CAPACITORS

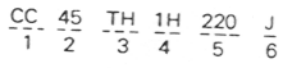

- 1 = Type ceramic, electrolytic, etc.
- 2 = Shape round, square, etc.
- 3 = Temp. coefficient
- 4 = Voltage rating
- 5 = Value
- 6 = Tolerance

• Temperature Coefficient

1st Word	C	L	P	R	S	T	U
Color*	Black	Red	Orange	Yellow	Green	Blue	Violet
ppm/°C	0	-80	-150	-220	-330	-470	-750

• Tolerance

Code	C	D	G	J	K	M	X	Z	P	No code
(%)	± 0.25	± 0.5	± 2	± 5	± 10	± 20	+ 40 - 20	+ 80 - 20	+ 100 - 0	More than Less than 10µF-10~+50 4.7µF-10~+75

Less than 10 pF

• Rating voltage

2nd word	A	B	C	D	E	F	G	H	J	K	V
1st word											
0	1.0	1.25	1.6	2.0	2.5	3.15	4.0	5.0	6.3	8.0	-
1	10	12.5	16	20	25	31.5	40	50	63	80	35
2	100	125	160	200	250	315	400	500	630	800	-
3	1000	1250	1600	2000	2500	3150	4000	5000	6300	8000	-

• Chip capacitors

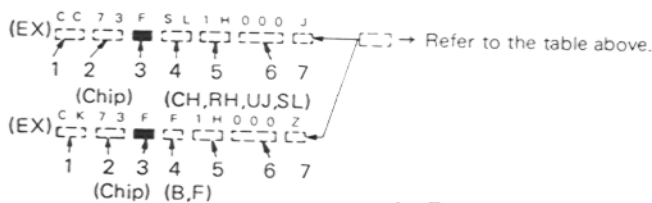

- 1 = Type ceramic, electrolytic, etc.
- 2 = Shape round, square, etc.
- 3 = Dimension
- 4 = Temp. coefficient
- 5 = Voltage rating
- 6 = Value
- 7 = Tolerance.

RESISTORS

• Chip resistor (Carbon)



• Carbon resistor (Normal type)

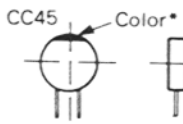

• Capacitor value

- 0 1 0 = 1pF
- 1 0 0 = 10pF
- 1 0 1 = 100pF
- 1 0 2 = 1000pF = 0.001µF

1 0 3 = 0.01µF

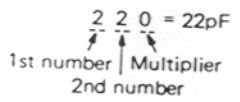

Example CC45TH = -470 ± 60 ppm/°C

Code	B	C	D	F	G
(pF)	± 0.1	± 0.25	± 0.5	± 1	± 2

Dimension

Dimension code	L	W	T
Empty	5.6 ± 0.5	5.0 ± 0.5	Less than 2.0
E	3.2 ± 0.2	1.6 ± 0.2	Less than 1.25
F	2.0 ± 0.3	1.25 ± 0.2	Less than 1.25

Dimension

Dimension code	L	W	T	Wattage
E	3.2 ± 0.2	1.6 ± 0.2	0.57	2B
F	2.0 ± 0.3	1.25 ± 0.2	0.45	2A

Rating wattage

Cord	Wattage	Cord	Wattage	Cord	Wattage
2A	1 10W	2E	1 4W	3A	1W
2B	1 8W	2H	1 2W	3D	2W
2C	1 6W				

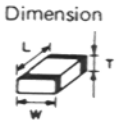

UNIT	MODEL	TR-751A (K, M1, M2)	TR-751E (W, T)
FINAL UNIT		X45-1490-11	X45-1490-11
CONTROL UNIT		X53-1460-11 (K, M1) X53-1460-21 (M2)	X53-1460-51 (T) X53-1460-61 (W)
COMPOSITE UNIT (PLL, TX)		X60-1310-11	X60-1310-01
COMPOSITE UNIT (RX)		X60-1320-11	X60-1320-00

TR-751A/E PC board chart

PARTS LIST

SEMICONDUCTOR

N : New parts

Item	Re- marks	Part No.	Item	Re- marks	Part No.	Item	Re- marks	Parts No.
Diode		1N60		N	MP-1BR001			3SK73(GR)
		1S1587		N	MP-2AA001			3SK74(L)
		1S2208		N	MP-2BG001			
		1SS101	LCD		FSD-8091A	Chip FET		2SK208(O)
		1SS106	Thermister		112-102-2	Power module		M57727
		1SS133			112-103-2	IC		AN612
		BA282			112-202-2			BU4584B
		MA856	TR		2SA1115(E)			
		MI308			2SA1162(Y)		N	DT5A143E
		MI407			2SA1307(Y)			DT5C124E
Varistor		U15B			2SC1815(Y)		N	L78N08
		VD1223			2SC2026		N	M5278L56
Vari-cap diode		1SV50			2SC2458(Y)		N	MB3712
		1SV153	Chip TR		2SC2538-22-A			NE555P
Chip diode		BB221			2SC3419(Y)			
		1SS181			2SA1162(Y)			NJM4558D
		1SS184			2SC2712(Y)			NJM4558M
		1SS226			2SC2714(Y)		N	PST523C
Zener diode	N	DAN202K	Digital TR	N	DTA114EK			SN16913P
	N	DAP202K		N	DTA114TK			TA7302P
	N	HSM88AS		N	DTA143EK			TA7310P
LED		MTZ6.2JA			DTC114EK		N	TA7761P
		MTZ11JC			DTC143EK		N	TC74HC390P
	LN322GP	FET		DTC144EK		N	TC5082P-G	
	LN422YP			2SK125		N	TC9172P	
				2SK129(Q,R)		N	μ PC78M08H	
				2SK161(GR)		N	μ PC4558C	
						N	μ PD7507SCT-215	
						N	μ PD7508HG-545-22	
						N	μ PD7514G-143-12	

TR-751E

PARTS LIST

* New Parts

Parts without Parts No. are not supplied.

Les articles non mentionnés dans le Parts No. ne sont pas fournis.

Telle ohne Parts No. werden nicht geliefert.

Ref. No. 参照番号	Address 位置	New Parts 新	Parts No. 部品番号	Description 部品名 / 規格	Desti- nation 仕向	Re- marks 備考	
TR-751A/E GENERAL							
1	1E	*	A01-1003-02	METALLIC CABINET(TOP)			
2	4D	*	A01-1004-02	METALLIC CABINET(BOTTOM)			
5	1B	*	A20-2568-13	PANEL ASSY	KM1M2 T W		
5	1B	*	A20-2569-13	PANEL ASSY			
5	1B	*	A20-2570-13	PANEL ASSY			
-			A13-0666-12	MOUNTING BRACKET(RIGHT)ACSY			
-			A13-0667-12	MOUNTING BRACKET(LEFT)ACSY			
-			A13-0668-04	MOUNTING BRACKET(ANGLE)ACSY			
10	2C, 3E 3D		B01-0655-13	PANEL ESCUTCHEON	KM1M2 TW		
11			B04-0411-04	SP METAL PLATE			
-		*	B10-0677-04	FRONT GLASS (COM)			
-		*	B10-0678-04	FRONT GLASS			
-			B11-0434-04	REFLECTION GLASS(FUNC.DCL)			
-		*	B40-3650-14	MODEL NAME PLATE			
-		*	B40-3651-04	MODEL NAME PLATE			
-		*	B42-2424-03	LABEL (COM)			
-		*	B42-2432-03	LABEL (TONE)			
-		*	B43-1068-04	BADGE (TR-751A)			
-		*	B43-1069-04	BADGE (TR-751E)TRIO			
-	*	B43-1070-04	BADGE (TR-751E)				
-		B46-0410-00	WARRANTY CARD	T W K			
-		B50-8069-00	INSTRUCTION MANUAL(TR-751A/E)	KM1M2W T			
-		B50-8070-00	INSTRUCTION MANU. (TR-751E)TRIO				
-		E09-0471-05	4P PLUG (ACSY)				
-		E30-2022-15	DC CORD (ACSY)				
31	3D		F20-0520-04	INSULATING BOARD			
-			F05-7025-05	FUSE (7A) ACSY			
-			F20-0521-04	INSULATING BOARD(LITHIUM BTRY)			
36	1A, 1B 3C		G01-0818-04	COILED SPRING			
37			G02-0505-05	KNOB FITTING SPRING			
38		1D	*	G02-0550-04	GND SPRING		
39		1D		G10-0626-04	FELT		
40		4D	*	G10-0643-04	NON-WOVEN FABRIC		
42	4D	*	G16-0508-04	VIBRATION PROTECTIVE			
-			G13-0823-04	CUSHION (ACSY)			
-			G53-0515-04	FELT			
-		*	H01-8010-03	ITEM CARTON BOX(TR-751A)	KM1M2 T W		
-		*	H01-8011-03	ITEM CARTON BOX(TR-751E)TRIO			
-		*	H01-8012-03	ITEM CARTON BOX(TR-751E)			
-		*	H10-2501-03	POLYSTYRENE FOAMED FIXTURE(TOP)			
-		*	H10-2612-02	POLYSTYRENE FOAMED FIXTURE(BTM)			
-		*	H13-0808-04	PROTECTIVE PLATE			
-			H25-0029-04	PROTECTION BAG (SCREW ETC.)			
-			H25-0103-04	PROTECTION BAG (MIC.MNT ANGLE)			
-			H25-0106-04	PROTECTION BAG (TR-751A/E)			
-			H25-0116-04	PROTECTION BAG (ACSY)			
-		H25-0117-04	PROTECTION BAG (DC CORD)				
63	4E		J02-0439-05	FOOT (ACSY)			
64	3D		J21-1144-34	SP MOUNTING HARDWARE			
65	1B		J29-0407-04	SWITCH GUIDE A (1-0)			
66	1B		J29-0409-04	SWITCH GUIDE			

PARTS LIST

* New Parts

Parts without Parts No. are not supplied.

Les articles non mentionnés dans le Parts No. ne sont pas fournis.

Telle ohne Parts No. werden nicht geliefert.

Ref. No. 参照番号	Address 位置	New Parts 新	Parts No. 部品番号	Description 部品名 / 規格	Desti- nation 仕向	Re- marks 備考
67	3C		J42-0449-05 J19-0319-24 J61-0408-05	PANEL BUSHING MIC HOOK WIRE BAND	K	
71	3C	*	K21-0780-03	MAIN TUNING KNOB		
72	3C	*	K23-0783-04	KNOB (AF VOL, RIT)		
73	1A	*	K27-0482-03	KNOB (BUTTON) KEY-1		
74	1A	*	K27-0483-03	KNOB (BUTTON) KEY-2		
75	1A	*	K27-0484-03	KNOB (BUTTON) KEY-3		
76	1A	*	K27-0485-03	KNOB (BUTTON) KEY-4		
77	1A	*	K27-0486-03	KNOB (BUTTON) KEY-5		
78	1A	*	K27-0487-03	KNOB (BUTTON) KEY-6		
79	1A	*	K27-0488-03	KNOB (BUTTON) KEY-7		
80	1A	*	K27-0489-03	KNOB (BUTTON) KEY-8		
81	1A	*	K27-0490-03	KNOB (BUTTON) KEY-9		
82	1A	*	K27-0491-03	KNOB (BUTTON) KEY-0		
83	1A, 1B		K29-3044-05	KNOB ASSY		
84	1A	*	K29-3045-05	KNOB ASSY (FUNC)		
85	3C	*	K29-3046-04	KNOB ASSY (SQ, RF GAIN)		
86	3C	*	K29-3047-04	KNOB RING		
-			N09-0008-04	HEX HEAD SCREW (ACSY)		
-			N09-0632-05	TAPTITE SCREW A (ACSY)		
-			N14-0510-04	NUT (ACSY)		
-			N15-1040-45	FLAT WASHER (MOUNTING BRACKET)		
-			N15-1060-46	FLAT WASHER (ACSY)		
-			N16-0060-46	SPRING WASHER (ACSY)		
-			N46-3010-46	BI. HEAD TAPTITE SCREW (ACSY)	K	
-			N99-0304-04	HEX. HEAD SCREW (MNT. ANGLE)		
A	2C, 3D		N09-0641-05	MACHINE SCREW (SUB PANEL)		
B	3C, 3D	*	N09-0700-04	STEPPED SCREW (PANEL)		
C	2A		N32-2004-46	FLAT HEAD MACHINE SCREW (CONT.)		
D	2D, 2E		N32-3006-46	FLAT HEAD MACHINE SCREW (SPKR)		
E	1D		N33-3006-45	OVAL HEAD MACHINE SCREW (SPKR)		
F	1B, 2B		N35-2005-46	BI. HEAD MACHINE SCREW (SW UNIT)		
G	2D, 3D		N87-2605-46	BR. HEAD TAPTITE SCREW (PCB)		
H	1D		N89-2605-46	BI. HEAD TAPTITE SCREW (PLL.)		
J	1D, 4E		N89-3006-45	BI. HEAD TAPTITE SCREW (CABINET)		
-			S50-1406-05	TACT SWITCH	M1M2T	
93	3D	*	T07-0241-05	LOUDSPEAKER (FULL RANGE)		
-		*	T91-0357-05	MICROPHONE	M1M2W	
-		*	T91-0358-05	MICROPHONE (TRIO)	T	
-		*	T91-0359-05	MICROPHONE	K	
-			LR4087	IC (TONE DIALER) NE MIC	K	
97	2D		W09-0326-05 W01-0401-05	LITHIUM BATTERY (BA2032) HEX WRENCH (ACSY)		
100	3A	*	X45-1490-11	FINAL UNIT		
101	2B, 3D	*	X53-1460-11	CONTROL UNIT	KM1	
101	2B, 3D	*	X53-1460-21	CONTROL UNIT	M2	
101	2B, 3D	*	X53-1460-51	CONTROL UNIT	T	
101	2B, 3D	*	X53-1460-61	CONTROL UNIT	W	
102	2D	*	X60-1310-01	COMPOSITE UNIT (PLL. TX)	TW	
102	2D	*	X60-1310-11	COMPOSITE UNIT (PLL. TX)	KM1M2	

PARTS LIST

× New Parts

Parts without Parts No. are not supplied.

Les articles non mentionnés dans le Parts No. ne sont pas fournis.

Teile ohne Parts No. werden nicht geliefert.

Ref. No. 参照番号	Address 位置	New Parts 新	Parts No. 部品番号	Description 部品名 / 規格	Desti- nation 仕 向	Re- marks 備考
103	3D	*	X60-1320-00	COMPOSITE UNIT (RX)	TW	
103	3D	*	X60-1320-11	COMPOSITE UNIT (RX)	KM1M2	
FINAL UNIT (X45-1490-11)						
110	3B	*	B42-2426-04	REAR PLATE (KEY,AUX)		
C1		*	C90-2039-05	ELECTRO 15UF 16WV		
C2			CK73FB1H102K	CHIP C 1000PF K		
C3			C90-0875-05	ELECTRO 100UF 16WV		
C4			CK73FB1H102K	CHIP C 1000PF K		
C5			C90-0871-05	ELECTRO 220UF 16WV		
C6			CK73FB1H102K	CHIP C 1000PF K		
C8			CC45SL2H100D	CERAMIC 10PF D		
C9			CC45CH1H010C	CERAMIC 1.0PF C		
C10			CC45SL2H220J	CERAMIC 22PF J		
C11			CK45B2H102K	CERAMIC 1000PF K		
C12 -14			CC45SL2H220J	CERAMIC 22PF J		
C15			CC45CH1H010C	CERAMIC 1.0PF C		
C16			CC45SL2H220J	CERAMIC 22PF J		
C17			CC45CH1H010C	CERAMIC 1.0PF C		
C18			CC45SL2H100D	CERAMIC 10PF D		
C19			CC45SL2H150J	CERAMIC 15PF J		
C20			CK73FB1H102K	CHIP C 1000PF K		
C21			CK45B1H102K	CERAMIC 1000PF K		
C22			CC45CH1H180J	CERAMIC 18PF J		
C23			CK45B1H102K	CERAMIC 1000PF K		
C24			CS15E1VR47M	TANTAL 0.47UF 35WV		
C25 -43			CK73FB1H102K	CHIP C 1000PF K		
111	3B		E04-0161-05	M TYPE RECEPTACLE (ANT)		
112	3B,2E		E30-2021-35	DC CABLE FOR REAR PANEL		
-			E23-0401-05	TERMINAL		
-			E31-3028-05	CABLE WITH TERMINAL		
J1			E40-3243-05	PIN CONNECTOR (8P)		
J2			E40-3239-05	PIN CONNECTOR (4P)		
J3	3B		E11-0401-05	EAR PHONE JACK		
J4	3A	*	E11-0424-05	PHONE JACK (KEY JACK)		
J5	3B		E08-0471-05	4P CONNECTOR		
JP1			E31-1448-05	CONNECTING WIRE		
JP2 ,3			E31-1449-05	CONNECTING WIRE		
JP4			E31-1448-05	CONNECTING WIRE		
JP5			E31-0381-05	CONNECTING WIRE		
JP6			E31-1449-05	CONNECTING WIRE		
JP7			E31-1960-05	CONNECTING WIRE		
115	3B,2E	*	F01-0940-15	HEAT SINK		
-			F05-7025-05	FUSE (7A)		
118	3B		J41-0017-05	BUSHING		
-			J61-0408-05	WIRE BAND		
L1			L34-1019-05	COIL (3,2.5T)		
L2			L34-0908-05	COIL (3,9.5T)		
L3			L34-0894-05	COIL (3,5T)		
L4			L34-0452-05	COIL (3,6T)		
L5			L34-0908-05	COIL (3,9.5T)		
L6			L34-0742-05	COIL (3,5T)		
L7			L40-1092-14	SMALL FIXED INDUCTOR(1U)		

PARTS LIST

× New Parts

Parts without Parts No. are not supplied.

Les articles non mentionnés dans le Parts No. ne sont pas fournis.

Telle ohne Parts No. werden nicht geliefert.

Ref. No. 参照番号	Address 位置	New Parts 新	Parts No. 部品番号	Description 部品名 / 規格	Desti- nation 仕向	Re- marks 備考
L8			L34-0823-05	COIL (S.3T)		
N	3A		N09-0623-04	SEMUS SCREW		
P	3B		N87-3008-41	BRAZIER HEAD TAPTITE SCREW		
Q	3A		N09-0626-04	SEMUS SCREW		
R2			RK73FB2A472J	CHIP R 4.7K J 1/10W		
R3			RK73FB2A182J	CHIP R 1.8K J 1/10W		
R4			RK73FB2A561J	CHIP R 560 J 1/10W		
R5			RD14DB2H181J	SMALL-RD 180 J 1/2W		
R6			RK73FB2A473J	CHIP R 47K J 1/10W		
R9			RK73FB2A104J	CHIP R 100K J 1/10W		
R10			RK73FB2A223J	CHIP R 22K J 1/10W		
VR1			R12-5423-05	TRIMMING PØT.		
VR2			R12-0434-05	TRIMMING PØT.		
VR3			R12-3455-05	TRIMMING PØT.		
RL 1			S51-1428-05	RELAY		
D1			U15B	DIØDE		
D2			1S1587	DIØDE		
D3 ,4			1SS101	DIØDE		
D5			MI407	DIØDE		
D6			MI308	DIØDE		
D9			1SS133	DIØDE		
D10			MTZ6.2JA	ZENER DIØDE		
Q1	3A		M57727	POWER MODULE		
Q2	3A		2SA1307(Y)	TRANSISTØR		
Q3			2SC1815(Y)	TRANSISTØR		
Q4			2SA1162(Y)	CHIP TRANSISTØR		
Q5			2SC2458(Y)	TRANSISTØR		
CONTROL UNIT (X53-1460-XX) -11 : K,M1 -21 : M2 -51 : T -61 : W						
-		*	A33-0405-03	REFLECTØR ASSY		
-		*	B11-0438-03	FILTER		
-		*	B11-0439-04	FILTER (TOP)		
-		*	B12-0701-04	INDICATING PLATE(BOTTOM)		
-		*	B31-0658-15	METER (MH-24A)		
D213		*	B30-0846-05	LED (LN422YP) AMBER		
D301		*	B30-0844-05	LED (MP-2A001)ORANGE		KM1M2
D302		*	B30-0842-05	LED (MP-1B001)RED		
D303-305		*	B30-0843-05	LED (MP-2BG001)GREEN		
D306		*	B30-0844-05	LED (MP-2A001)ORANGE		
D307		*	B30-0843-05	LED (MP-2BG001)GREEN		
D308		*	B30-0842-05	LED (MP-1B001)RED		
PL1		*	B30-0845-05	LAMP FOR METER (12V,60MA)		
PL301,302		*	B30-0828-05	LAMP (12V,60MA)GREEN CAP		
C1			CK73FB1H103K	CHIP C 0.010UF K		
C2 -7			CK73FB1H102K	CHIP C 1000PF K		
C8			CK73FB1H103K	CHIP C 0.010UF K		
C9 -11			CK73FB1H102K	CHIP C 1000PF K		
C12			CK73FB1E223K	CHIP C 0.022UF K		
C13 ,14			CK73FB1H103K	CHIP C 0.010UF K		
C15		*	C90-2041-05	ELECTRØ 10UF 10WV		
C16			CK73FB1H103K	CHIP C 0.010UF K		
C17			C90-0864-05	ELECTRØ 220UF 10WV		
C18			C90-0822-05	ELECTRØ 47UF 16WV		

PARTS LIST

* New Parts

Parts without Parts No. are not supplied.

Les articles non mentionnés dans le Parts No. ne sont pas fournis.

Telle ohne Parts No. werden nicht geliefert.

Ref. No. 参照番号	Address 位置	New Parts 新	Parts No. 部品番号	Description 部品名/規格	Desti- nation 仕向	Re- marks 備考
C19			CK73FB1H103K	CHIP C 0.010UF K		
C20	.21		CK73FB1H102K	CHIP C 1000PF K		
C22			C90-0824-05	ELECTRØ 1UF 50WV		
C29			CK73FB1H102K	CHIP C 1000PF K	TW	
C30			CK73FB1H472K	CHIP C 4700PF K	TW	
C31			CK73FB1H103K	CHIP C 0.010UF K	TW	
C32		*	CK73EB1H333K	CHIP C 0.033UF K	TW	
C33			C90-0480-05	ELECTRØ 47UF 10WV	TW	
C34			CK73FB1H103K	CHIP C 0.010UF K	TW	
C35			C91-0433-05	CERAMIC CAPACITØR (0.039U)	TW	
C36	.37		CK73FB1H102K	CHIP C 1000PF K		
C38			CK73FB1H103K	CHIP C 0.010UF K		
C39	-44		CC73FCH1H101J	CHIP C 100PF J		
C45			C90-0824-05	ELECTRØ 1UF 50WV		
C46			CK73FB1H103K	CHIP C 0.010UF K		
C201		*	CK73FB1H182K	CHIP C 1800PF K		
C202			CK73FB1H102K	CHIP C 1000PF K		
C204			CK73FB1H332K	CHIP C 3300PF K		
C205			CK73FB1H471K	CHIP C 470PF K		
C206			CE04CW1C100M	ELECTRØ 10UF 16WV		
C207-208			CK73FB1E223K	CHIP C 0.022UF K		
C209			CK73FB1H102K	CHIP C 1000PF K		
C210			CK73FB1H103K	CHIP C 0.010UF K		
C211			CC73FCH1H101J	CHIP C 100PF J		
C212-215			CK73FB1H102K	CHIP C 1000PF K		
C216-219			CK73FB1E223K	CHIP C 0.022UF K		
C220			CK73FB1H102K	CHIP C 1000PF K		
C221		*	CK73EB1H473K	CHIP C 0.047UF K		
C222			CK73FB1H102K	CHIP C 1000PF K		
C223		*	C90-2031-05	ELECTRØ 4.7UF 10WV		
C301-304			CK73FB1H103K	CHIP C 0.010UF K		
C305			CC73FCH1H330J	CHIP C 33PF J		
-			E06-0858-05	8P METAL SOCKET		
-			E23-0512-05	TERMINAL (1P)		
-			E29-0428-04	TERMINAL		
-		*	E29-0469-08	CØNNECTØR		
-		*	E31-3187-08	CØNNECTING WIRE(TSB-P07H-A1)		
J1		*	E40-5069-05	PIN CØNNECTØR (12P)		
J2			E40-5068-05	PIN CØNNECTØR (11P)		
J3			E40-3242-05	PIN CØNNECTØR (7P)		
J4			E40-3240-05	PIN CØNNECTØR (5P)		
J5		*	E40-5067-05	PIN CØNNECTØR (10P)		
J6			E40-3243-05	PIN CØNNECTØR (8P)		
J7			E40-5021-05	PIN CØNNECTØR (7P)		
J8	.9		E40-5022-05	PIN CØNNECTØR (8P)	KM1M2	
J10			E40-5019-05	PIN CØNNECTØR (5P)		
J201			E40-3237-05	PIN CØNNECTØR (2P)		
J202			E40-3241-05	PIN CØNNECTØR (6P)		
J204			E40-3243-05	PIN CØNNECTØR (8P)		
J205			E40-3238-05	PIN CØNNECTØR (3P)		
TP1			E40-0211-05	PIN CØNNECTØR (2P)		
TP9			E40-0211-05	PIN CØNNECTØR (2P)	TW	
-		*	J19-1421-04	CØVER		

PARTS LIST

* New Parts

Parts without Parts No. are not supplied.

Les articles non mentionnés dans le Parts No. ne sont pas fournis.

Teile ohne Parts No. werden nicht geliefert.

Ref. No. 参照番号	Address 位置	New Parts 新	Parts No. 部品番号	Description 部品名 / 規格	Desti- nation 仕向	Re- marks 備考
X1		*	L78-0017-05	RESONATOR (4.194MHZ)FAR.C4SA		
-			N09-0608-05	SCREW		
-		*	N09-0698-05	SCREW (Ø1.7X5)		
JR201,202 JR301,302			R92-0670-05	CHIP R 0 ΩHM		
R1			R92-0670-05	CHIP R 0 ΩHM		
R2 ,3		*	R90-0462-05	MULTI-COMP (47KX8)		
R9			RK73FB2A103J	CHIP R 10K J 1/10W		
			RK73FB2A473J	CHIP R 47K J 1/10W		
R10			RK73FB2A472J	CHIP R 4.7K J 1/10W		
R11 -15			RK73FB2A473J	CHIP R 47K J 1/10W		
R16 ,17			RK73FB2A273J	CHIP R 27K J 1/10W		
R18			RK73FB2A103J	CHIP R 10K J 1/10W		
R19			RK73FB2A471J	CHIP R 470 J 1/10W		
R20			RD14DB2H470J	SMALL-RD 47 J 1/2W		*1
R21			RK73FB2A473J	CHIP R 47K J 1/10W		*2,3
R21			RK73FB2A563J	CHIP R 56K J 1/10W		
R22			RK73FB2A222J	CHIP R 2.2K J 1/10W		TW*1
R23			R92-0670-05	CHIP R 0 ΩHM		KM1M2
R24			RK73FB2A183J	CHIP R 18K J 1/10W		KM1M2
R32			RK73FB2A333J	CHIP R 33K J 1/10W		TW
R33			RK73FB2A393J	CHIP R 39K J 1/10W		TW*3
R33			RK73FB2A473J	CHIP R 47K J 1/10W		TW
R34			RK73FB2A123J	CHIP R 12K J 1/10W		TW*1
R35			RK73FB2A472J	CHIP R 4.7K J 1/10W		TW
R36			RN14BK2B9102F	RN 91.0K F 1/8W		TW
R37			RK73FB2A560J	CHIP R 56 J 1/10W		
R38			RK73FB2A273J	CHIP R 27K J 1/10W		
R39			RK73FB2A104J	CHIP R 100K J 1/10W		TW*1
R39			R92-0670-05	CHIP R 0 ΩHM		TW*3
R40			RK73FB2A472J	CHIP R 4.7K J 1/10W		
R41			RK73FB2A332J	CHIP R 3.3K J 1/10W		
R201			RK73FB2A103J	CHIP R 10K J 1/10W		
R203			RK73FB2A823J	CHIP R 82K J 1/10W		
R204			RK73FB2A182J	CHIP R 1.8K J 1/10W		
R204			RK73FB2A683J	CHIP R 68K J 1/10W		
R205		*	RK73FB2A684J	CHIP R 680K J 1/10W		
R206			RK73FB2A564J	CHIP R 560K J 1/10W		
R207			RK73FB2A103J	CHIP R 10K J 1/10W		
R208,209			RK73FB2A182J	CHIP R 1.8K J 1/10W		
R210,211			RK73FB2A153J	CHIP R 15K J 1/10W		
R214		*	R90-0462-05	MULTI-COMP (47KX8)		
R215-217			RK73FB2A102J	CHIP R 1.0K J 1/10W		
R218			RK73FB2A101J	CHIP R 100 J 1/10W		
R220			RK73FB2A103J	CHIP R 10K J 1/10W		
R221		*	RK73EB2B821J	CHIP R 820 J 1/8W		
R222		*	RK73EB2B122J	CHIP R 1.2K J 1/8W		
R224		*	RK73EB2B122J	CHIP R 1.2K J 1/8W		
R225		*	RK73EB2B821J	CHIP R 820 J 1/8W		
R301-303		*	RK73EB2B152J	CHIP R 1.5K J 1/8W		KM1M2
R304-307			RK73EB2B222J	CHIP R 2.2K J 1/8W		
R308,309		*	RK73EB2B123J	CHIP R 12K J 1/8W		
R310		*	RK73EB2B393J	CHIP R 39K J 1/8W		
VR1			R12-4417-05	TRIMMING PNT. (50K)RVF6W01		

*1 : S/No. 705-707XXXX (W,T)

*2 : S/No. 705-707XXXX (K,M1,M2)

*3 : S/No. 708XXXX- (K,M1,M2,W,T)

PARTS LIST

* New Parts

Parts without Parts No. are not supplied.

Les articles non mentionnés dans le Parts No. ne sont pas fournis.

Telle ohne Parts No. werden nicht geliefert.

Ref. No. 参照番号	Address 位置	New Parts 新	Parts No. 部品番号	Description 部品名 / 規格	Desti- nation 仕向	Re- marks 備考
VR2 VR4 VR5	2A 2A	*	R12-3523-05 R23-3403-05 R23-9402-05	TRIMMING P0T. (20K)TM64K2 PH P0TENTI0METER(100KBX2) P0TENTI0METER(10K,50KB)	TW	
S201-204 S205 S206,207 S208 S209-218		*	S40-1411-05 S40-2444-05 S40-2443-05 S40-2444-05 S50-1426-05	TACT SWITCH (9.5MM) PUSH SWITCH (NON LOCK) PUSH SWITCH (LOCK) PUSH SWITCH (NON LOCK) TACT SWITCH (5MM)		
S219-223 S225		*	S40-1411-05 S31-1411-05	TACT SWITCH (9.5MM) SLIDE SWITCH		
-		*	FSD-8091B	LCD		
D1 ,2 D3 D4 D4 ,5			1SS133 1SS133 1SS133 1SS133	DI0DE DI0DE DI0DE DI0DE	KM1M2 KM1 W	
D6 ,7 D8 D11 ,12 D14 D16 -18			1SS133 1SS133 1SS133 1SS133 1SS133	DI0DE DI0DE DI0DE DI0DE DI0DE	TW	
D19 ,20 D19 ,20 D21 D21 D22 ,24			DAN202K 1SS184 DAP202K 1SS181 1SS133	CHIP DI0DE CHIP DI0DE CHIP DI0DE CHIP DI0DE DI0DE		
D25 ,26 D25 ,26 D27 D27 D29			DAN202K 1SS184 DAP202K 1SS181 1SS106	CHIP DI0DE CHIP DI0DE CHIP DI0DE CHIP DI0DE DI0DE		
D30 D30 D31 D31 D201-206			DAN202K 1SS184 DAN202K 1SS184 DAP202K	CHIP DI0DE CHIP DI0DE CHIP DI0DE CHIP DI0DE CHIP DI0DE	TW TW	
D201-206 D207-211 D212 IC1 IC2		*	1SS181 1SS133 LN3226P UPD7508HG545-22 DT5C124E	CHIP DI0DE DI0DE LED (GREEN) IC (4BIT,4K) IC		
IC3 IC4 IC5 IC6 IC20		*	DT5A143E UPD7507SCT-215 M5278L56 NE555P BU4584B	IC IC(MICR0P0CESS0R)1T,2K) IC(V0LTAGE REGULAT0R/ +5.6V) IC IC(INVERTER X6)	TW	
IC202 IC301 Q1 ,2 Q3 Q4		*	PST523C UPD7514G-143-12 DTC114EK 2SC2712(Y) DTC114EK	IC(SYSTEM RESET) IC(MICR0P0CESS0R) DIGITAL TRANSIST0R CHIP TRANSIST0R DIGITAL TRANSIST0R		
Q5 Q6 Q7 ,8 Q201-203		*	DTA114TK DTC114EK DTA114EK DTC114EK	DIGITAL TRANSIST0R DIGITAL TRANSIST0R DIGITAL TRANSIST0R DIGITAL TRANSIST0R		

PARTS LIST

* New Parts

Parts without Parts No. are not supplied.

Les articles non mentionnés dans le Parts No. ne sont pas fournis.

Telle ohne Parts No. werden nicht geliefert.

Ref. No. 参照番号	Address 位置	New Parts 新	Parts No. 部品番号	Description 部品名 / 規格	Desti- nation 仕向	Re- marks 備考
Q301 Q302 TH1		*	DTC114EK	DIGITAL TRANSISTOR	KM1M2	
		*	DTC114EK 112-103-2	DIGITAL TRANSISTOR THERMISTOR		
- S224		*	W02-0376-05	LCD ASSY	KM1M2 TW	
		*	W02-0377-05	LCD ASSY		
		*	W02-0374-05	ROTARY ENCODER (SGF)		
SUB VCO (X58-1000-XX) -00 : W,T -11 : K,M1,M2						
C1			C092M1H473K	MYLAR 0.047UF K	TW KM1M2	
C2			CK73FB1H102K	CHIP C 1000PF K		
C3			CC73FCH1H150J	CHIP C 15PF J		
C4			CC73FCH1H060D	CHIP C 6.0PF D		
C4			CC73FCH1H080D	CHIP C 8.0PF D		
C5			CC73FCH1H060D	CHIP C 6.0PF D	KM1M2	
C5			CC73FCH1H070D	CHIP C 7.0PF D		
C6			CK73FB1H102K	CHIP C 1000PF K	TW	
C7			CC73FCH1H120J	CHIP C 12PF J		
C7			CC73FCH1H180J	CHIP C 18PF J	TW KM1M2	
C8			CC73FCH1H050C	CHIP C 5.0PF C	KM1M2	
C9			CK73FB1H102K	CHIP C 1000PF K		
TC1			C05-0031-15	TRIMMING CAP (10P)		
-			E23-0464-05	TERMINAL (9.8MM)		
-		*	F11-1018-04	SHIELDING COVER(VCOA)		
-		*	F11-1021-04	SHIELDING COVER(CASE)		
L1		*	L33-0690-05	CHOKER COIL (3.3UH)		
L2			L32-0664-05	OSCILLATING COIL		
R1			RK73FB2A472J	CHIP R 4.7K J 1/10W	KM1M2	
R1			RK73FB2A682J	CHIP R 6.8K J 1/10W		
R2			RK73FB2A331J	CHIP R 330 J 1/10W	TW	
R2			RK73FB2A561J	CHIP R 560 J 1/10W	TW	
R3			RK73FB2A104J	CHIP R 100K J 1/10W	KM1M2	
R4			RK73FB2A470J	CHIP R 47 J 1/10W	KM1M2	
R5			RK73FB2A122J	CHIP R 1.2K J 1/10W		
D1			1SV50	VARI CAP		
Q1			2SK125	FET		
Q2			25C2714(Y)	CHIP TRANSISTOR		
FM MIC AMP (X59-1090-00) S/No. 705-707XXXX : W,T						
C1			CC73FCH1H330J	CHIP C 33PF J		
C2			CK73FB1H561K	CHIP C 560PF K		
C3			CC73FCH1H390J	CHIP C 39PF J		
C4			CK73FB1H102K	CHIP C 1000PF K		
-			E23-0471-05	TERMINAL		
R1			RK73FB2A105J	CHIP R 1.0M J 1/10W	KM1M2	
R2			RK73FB2A823J	CHIP R 82K J 1/10W		
R3			RK73FB2A562J	CHIP R 5.6K J 1/10W	TW	
R4			RK73FB2A472J	CHIP R 4.7K J 1/10W	TW	
R5	.6		RK73FB2A224J	CHIP R 220K J 1/10W	KM1M2	
IC1			NJM4558M	IC(OP AMP X2)		
-6V DC-DC (X59-1100-00)						
C1	.2		CK73FB1H222K	CHIP C 2200PF K		

PARTS LIST

× New Parts

Parts without Parts No. are not supplied.

Les articles non mentionnés dans le Parts No. ne sont pas fournis.

Telle ohne Parts No. werden nicht geliefert.

Ref. No. 参照番号	Address 位置	New Parts 新	Parts No. 部品番号	Description 部品名 / 規格	Desti- nation 仕 向	Re- marks 備考
-			E23-0471-05	TERMINAL		
JR1 -3			R92-0670-05	CHIP R 0 ΩHM		
R1			RK73FB2A272J	CHIP R 2.7K J 1/10W		
R2 -4			RK73FB2A473J	CHIP R 47K J 1/10W		
R2 ,3			RK73FB2A223J	CHIP R 22K J 1/10W		
R5			RK73FB2A471J	CHIP R 470 J 1/10W		
D1		*	1SS226	CHIP DIODE		
Q1 ,2			2SC2712(Y)	CHIP TRANSISTOR		
Q3			2SA1162(Y)	CHIP TRANSISTOR		
AF PRE AMP (X59-1110-00)						
C1			CK73FB1H103K	CHIP C 0.010UF K		
C2			CK73FB1H392K	CHIP C 3900PF K		
C3			CC73FCH1H101J	CHIP C 100PF J		
C4			CK73FB1H471K	CHIP C 470PF K		
-			E23-0471-05	TERMINAL		
JR1 ,2			R92-0670-05	CHIP R 0 ΩHM		
R1			RK73FB2A123J	CHIP R 12K J 1/10W		
R2			RK73FB2A473J	CHIP R 47K J 1/10W		
R3			RK73FB2A272J	CHIP R 2.7K J 1/10W		
R4		*	RK73FB2A151J	CHIP R 150 J 1/10W		
R5			RK73FB2A472J	CHIP R 4.7K J 1/10W		
R6			RK73FB2A562J	CHIP R 5.6K J 1/10W		
R7			RK73FB2A153J	CHIP R 15K J 1/10W		
R8			RK73FB2A105J	CHIP R 1.0M J 1/10W		
Q1 ,2			2SC2712(Y)	CHIP TRANSISTOR		
SQUELCH SWITCH (X59-1120-00)						
-			E23-0471-05	TERMINAL		
R1 -3			RK73FB2A103J	CHIP R 10K J 1/10W		
R4 ,5			RK73FB2A223J	CHIP R 22K J 1/10W		
R6			RK73FB2A474J	CHIP R 470K J 1/10W		
R7			RK73FB2A472J	CHIP R 4.7K J 1/10W		
D1 ,2			1SS184	CHIP DIODE		
Q1 -3			2SC2712(Y)	CHIP TRANSISTOR		
CW BREAK IN (X59-1130-00)						
-			E23-0471-05	TERMINAL		
R1			RK73FB2A563J	CHIP R 56K J 1/10W		
R2			RK73FB2A333J	CHIP R 33K J 1/10W		
R3			RK73FB2A103J	CHIP R 10K J 1/10W		
R4			RK73FB2A222J	CHIP R 2.2K J 1/10W		
R5			RK73FB2A103J	CHIP R 10K J 1/10W		
R6			RK73FB2A153J	CHIP R 15K J 1/10W		
R7			RK73FB2A682J	CHIP R 6.8K J 1/10W		
R8			RK73FB2A103J	CHIP R 10K J 1/10W		
R9			RK73FB2A222J	CHIP R 2.2K J 1/10W		
Q1			DTA114EK	DIGITAL TRANSISTOR		
Q2 -4			2SC2712(Y)	CHIP TRANSISTOR		
FM MIC AMP (X59-3000-00) S/No. 705-707XXXX : K,M1,M2						
FM MIC AMP (X59-3000-01) S/No. 708XXXX- : K,M1,M2,W,T						
C1			CC73FCH1H101J	CHIP C 100PF J		
C2			CK73FB1H561K	CHIP C 560PF K		
C3			CC73FCH1H390J	CHIP C 39PF J		

PARTS LIST

* New Parts

Parts without Parts No. are not supplied.

Les articles non mentionnés dans le Parts No. ne sont pas fournis.

Teile ohne Parts No. werden nicht geliefert.

Ref. No. 参照番号	Address 位置	New Parts 新	Parts No. 部品番号	Description 部品名 / 規格	Desti- nation 仕向	Re- marks 備考
C4			CK73FB1H102K	CHIP C		
C5		*	CK73FB1H223K	CHIP C	1000PF K	
-			E23-0471-05	TERMINAL	0.022UF K	
R1			RK73FB2A105J	CHIP R	1.0M J	1/10W
R2			RK73FB2A823J	CHIP R	82K J	1/10W
R3			RK73FB2A562J	CHIP R	5.6K J	1/10W
R4			RK73FB2A472J	CHIP R	4.7K J	1/10W
R5 .6			RK73FB2A224J	CHIP R	220K J	1/10W
R7			RK73FB2A224J	CHIP R	220K J	1/10W
R8			RK73FB2A182J	CHIP R	1.8K J	1/10W
R9			RK73FB2A104J	CHIP R	100K J	1/10W
IC1			NJM4558M	IC(8P AMP X2)		
Q1			2SC2712(Y)	CHIP TRANSISTOR		
COMPOSITE UNIT (PLL, TX) (X60-1310-XX) -11 : K,M1,M2 -01 : W,T						
C1			CC73FCH1H680J	CHIP C	68PF J	
C2			CC73FCH1H470J	CHIP C	47PF J	
C3 .4			CC73FCH1H080D	CHIP C	8.0PF D	
C5 .6			CK73FB1H102K	CHIP C	1000PF K	
C7 .8			CC73FCH1H120J	CHIP C	12PF J	
C9			CC73FCH1HOR5C	CHIP C	0.5PF C	
C10			CK73FB1H102K	CHIP C	1000PF K	
C11			CC73FCH1H060D	CHIP C	6.0PF D	
C12			CC73FCH1H040C	CHIP C	4.0PF C	
C13			CC73FCH1H050C	CHIP C	5.0PF C	
C14			CC73FCH1HOR5C	CHIP C	0.5PF C	
C15			CC73FCH1H070D	CHIP C	7.0PF D	
C16			CC73FCH1H060D	CHIP C	6.0PF D	
C17			CK73FB1H102K	CHIP C	1000PF K	
C18			CC73FCH1HOR5C	CHIP C	0.5PF C	
C19			CC73FCH1H060D	CHIP C	6.0PF D	
C20			CC73FCH1H040C	CHIP C	4.0PF C	
C21			CK73FB1H102K	CHIP C	1000PF K	
C22			CC73FCH1H040C	CHIP C	4.0PF C	
C23 -26			CK73FB1H102K	CHIP C	1000PF K	
C27			CC73FCH1H070D	CHIP C	7.0PF D	
C28			CK73FB1E223K	CHIP C	0.022UF K	
C29			CK73FB1H102K	CHIP C	1000PF K	
C30			CC73FCH1H080D	CHIP C	8.0PF D	
C31 .32			CK73FB1H102K	CHIP C	1000PF K	
C34			CK73FB1H102K	CHIP C	1000PF K	
C35			C90-0478-05	ELECTRON	10UF 16WV	
C36 .37			CK73FB1H102K	CHIP C	1000PF K	
C38			C90-0478-05	ELECTRON	10UF 16WV	
C39			CC73FCH1H150J	CHIP C	15PF J	
C43			CK73FB1H102K	CHIP C	1000PF K	
C45			CK73FB1H103K	CHIP C	0.010UF K	
C46			CS15E1VR47M	TANTAL	0.47UF 35WV	
C47 -51			CK73FB1H102K	CHIP C	1000PF K	
C52			CK73FB1E223K	CHIP C	0.022UF K	
C53 .54			CK73FB1H102K	CHIP C	1000PF K	
C55			C092M1H104K	MYLAR	0.10UF K	
C56			C90-0897-05	ELECTRON	470UF 16WV	
C57			CK73FB1H102K	CHIP C	1000PF K	

PARTS LIST

* New Parts

Parts without Parts No. are not supplied.

Les articles non mentionnés dans le Parts No. ne sont pas fournis.

Teile ohne Parts No. werden nicht geliefert.

Ref. No. 参照番号	Address 位置	New Parts 新	Parts No. 部品番号	Description 部品名 / 規格	Desti- nation 仕向	Re- marks 備考
C58			C90-0867-05	ELECTR0 100UF 25WV		
C59			CE04W1A470M	ELECTR0 47UF 10WV		
C60			C90-0824-05	ELECTR0 1UF 50WV		
C61			CK73FB1H182K	CHIP C 1800PF K		
C62			CC73FSL1H471J	CHIP C 470PF J		
C63			C90-0867-05	ELECTR0 100UF 25WV		
C64 -66			CC73FSL1H101J	CHIP C 100PF J		
C67			CK73FB1H102K	CHIP C 1000PF K		
C68			CK73FB1E223K	CHIP C 0.022UF K		
C69 ,70			C90-0478-05	ELECTR0 10UF 16WV		
C71 -74			CK73FB1H103K	CHIP C 0.010UF K		
C75			CS15E1V0R1M	TANTAL 0.1UF 35WV		
C76			CK73FB1H102K	CHIP C 1000PF K		
C78			CK73FB1H102K	CHIP C 1000PF K		
C79			CS15E1C3R3M	TANTAL 3.3UF 16WV		
C81			CK73FB1H103K	CHIP C 0.010UF K		
C82			CK73FB1H102K	CHIP C 1000PF K		
C83			CS15E1V0R1M	TANTAL 0.1UF 35WV		
C84			CS15E1C3R3M	TANTAL 3.3UF 16WV		
C85 -87			CK73FB1H102K	CHIP C 1000PF K		
C88			CC73FSL1H101J	CHIP C 100PF J		
C89			CK73FB1H102K	CHIP C 1000PF K		
C90			CC73FCH1H220J	CHIP C 22PF J		
C91			CK73FB1H103K	CHIP C 0.010UF K		
C92 ,93			CK73FB1H102K	CHIP C 1000PF K		
C94			CK73FB1H103K	CHIP C 0.010UF K		
C95			CK73FB1H102K	CHIP C 1000PF K		
C96			CC73FCH1H060D	CHIP C 6.0PF D	TW	
C96			CC73FCH1H080D	CHIP C 8.0PF D	KM1M2	
C97			CC73FCH1H100D	CHIP C 10PF D		
C98 -100			CK73FB1H102K	CHIP C 1000PF K		
C101			CC73FCH1H030C	CHIP C 3.0PF C		
C102			CC73FCH1H050C	CHIP C 5.0PF C		
C103			CC73FCH1H0R5C	CHIP C 0.5PF C		
C104			CK73FB1H103K	CHIP C 0.010UF K		
C105-108			CK73FB1E223K	CHIP C 0.022UF K		
C109			CC73FCH1H120J	CHIP C 12PF J		
C110			CK73FB1H102K	CHIP C 1000PF K		
C111			CC73FCH1H680J	CHIP C 68PF J		
C112			CK73FB1E223K	CHIP C 0.022UF K		
C113			CK73FB1H102K	CHIP C 1000PF K		
C114			CC73FCH1H470J	CHIP C 47PF J		
C115			CC73FCH1H330J	CHIP C 33PF J		
C116			CK73FB1E223K	CHIP C 0.022UF K		
C117, 118			CC73FSL1H101J	CHIP C 100PF J		
C119			CC73FCH1H180J	CHIP C 18PF J		
C120			CC73FCH1H270J	CHIP C 27PF J		
C121			CC73FCH1H080D	CHIP C 8.0PF D		
C122			CC73FCH1H070D	CHIP C 7.0PF D		
C123			CC73FCH1H080D	CHIP C 8.0PF D		
C124			CC73FCH1H330J	CHIP C 33PF J		
C125			CK73FB1E223K	CHIP C 0.022UF K		
C126			CC73FSL1H101J	CHIP C 100PF J		
C127			CK73FB1H103K	CHIP C 0.010UF K		
C128			CE04W1A470M	ELECTR0 47UF 10WV		

PARTS LIST

× New Parts

Parts without Parts No. are not supplied.

Les articles non mentionnés dans le Parts No. ne sont pas fournis.

Teile ohne Parts No. werden nicht geliefert.

Ref. No. 参照番号	Address 位置	New Parts 新	Parts No. 部品番号	Description 部品名 / 規格	Desti- nation 仕向	Re- marks 備考
C129			CC73FCH1H150J	CHIP C 15PF J		
C130			CC73FCH1H470J	CHIP C 47PF J		
C131, 132			CK73FB1H102K	CHIP C 1000PF K		
C133			CC73FCH1H150J	CHIP C 15PF J		
C134			CK73FB1E223K	CHIP C 0.022UF K		
C135			CC73FCH1H150J	CHIP C 15PF J		
C136			CK73FB1H102K	CHIP C 1000PF K		
C137			CC73FSL1H471J	CHIP C 470PF J		
C138			CK73FB1H102K	CHIP C 1000PF K		
C139, 140			CK73FB1H103K	CHIP C 0.010UF K		
C141			CK73FB1H102K	CHIP C 1000PF K		
C142			CK73FB1H103K	CHIP C 0.010UF K		
C144		*	CC73FUJ1H270J	CHIP C 27PF J		
C145			CC73FUJ1H390J	CHIP C 39PF J		
C146			CC73FSL1H101J	CHIP C 100PF J		
C147			CC73FSL1H151J	CHIP C 150PF J		
C148			CK73FB1H103K	CHIP C 0.010UF K		
C149			CE04W1A470M	ELECTRØ 47UF 10WV		
C150			CC73FCH1H150J	CHIP C 15PF J		
C151			CC73FCH1HOR5C	CHIP C 0.5PF C		
C152			CK73FB1H102K	CHIP C 1000PF K		
C153			CK73FB1H103K	CHIP C 0.010UF K		
C154			CK73FB1E223K	CHIP C 0.022UF K		
C155			CC73FCH1H080D	CHIP C 8.0PF D		
C156			CC73FSL1H471J	CHIP C 470PF J		
C157			CK73FB1H102K	CHIP C 1000PF K		
C158			CC73FSL1H471J	CHIP C 470PF J		
C159			CC73FCH1H470J	CHIP C 47PF J		
C160			CK73FB1E223K	CHIP C 0.022UF K		
C161-163			CK73FB1H102K	CHIP C 1000PF K		
C164, 165			CS15E1E010M	TANTAL 1.0UF 25WV		
C166			CK73FB1H103K	CHIP C 0.010UF K		
C167			CE04W1A470M	ELECTRØ 47UF 10WV		
C168			CQ92M1H222K	MYLAR 2200PF K		
C169			CK73FB1H103K	CHIP C 0.010UF K		
C170			CE04W1A470M	ELECTRØ 47UF 10WV		
C171, 172			CK73FB1E223K	CHIP C 0.022UF K		
C173			CK73FB1H102K	CHIP C 1000PF K		
C174			CC73FSL1H101J	CHIP C 100PF J		
C175			CE04CW1A470M	ELECTRØ 47UF 10WV		
C176			CE04W1E101M	ELECTRØ 100UF 25WV		
C177			CK73FB1H103K	CHIP C 0.010UF K		
C178			CK73FB1E223K	CHIP C 0.022UF K		
C179			CE04W1HR47M	ELECTRØ 0.47UF 50WV		
C180-183			CC73FSL1H101J	CHIP C 100PF J		
C184			CK73FB1H102K	CHIP C 1000PF K		
C185			CE04W1A470M	ELECTRØ 47UF 10WV		
C186			CK73FB1E223K	CHIP C 0.022UF K		
C187			CQ92M1H473K	MYLAR 0.047UF K		
C188			CK73FB1H103K	CHIP C 0.010UF K		
C189			CQ92M1H822K	MYLAR 8200PF K		
C190			CK73FB1H103K	CHIP C 0.010UF K		
C191			CE04CW1A470M	ELECTRØ 47UF 10WV		
C192			CK73FB1H102K	CHIP C 1000PF K		
C193, 194			CC73FCH1H180J	CHIP C 18PF J		

PARTS LIST

× New Parts

Parts without Parts No. are not supplied.

Les articles non mentionnés dans le Parts No. ne sont pas fournis.

Telle ohne Parts No. werden nicht geliefert.

Ref. No. 参照番号	Address 位置	New Parts 新	Parts No. 部品番号	Description 部品名 / 規格	Desti- nation 仕 向	Re- marks 備考
C195,196 C197 C198 C199 C200			CC73FCH1H330J CK73FB1H103K CE04W1A470M CC73FCH1H030C CK73FB1H103K	CHIP C 33PF J CHIP C 0.010UF K ELECTRO 47UF 10WV CHIP C 3.0PF C CHIP C 0.010UF K		
C201,202 C203 C204 C205 C206			CC73FCH1H120J CC73FCH1H150J CC73FCH1H470J CK73FB1E223K CE04W1A470M	CHIP C 12PF J CHIP C 15PF J CHIP C 47PF J CHIP C 0.022UF K ELECTRO 47UF 10WV		
C207,208 C209 C210 C211 C212			CK73FB1H103K CC73FCH1H270J CK73FB1H103K CC73FCH1H220J CC73FCH1H470J	CHIP C 0.010UF K CHIP C 27PF J CHIP C 0.010UF K CHIP C 22PF J CHIP C 47PF J		
C213-216 C217,218 C219 C220 C221			CK73FB1H103K CC73FSL1H221J CK73FB1H103K CC73FCH1H030C CC73FCH1H270J	CHIP C 0.010UF K CHIP C 220PF J CHIP C 0.010UF K CHIP C 3.0PF C CHIP C 27PF J		
C222-224 C225 C226 C228 C229			CK73FB1H103K CC73FCH1H0R5C CK73FB1H102K CC73FSL1H101J CK73FB1H103K	CHIP C 0.010UF K CHIP C 0.5PF C CHIP C 1000PF K CHIP C 100PF J CHIP C 0.010UF K		
C230 C231-234 TC1 -3 TC4 .5 TC6 .7			CK73FB1E223K CK73FB1H102K C05-0030-15 C05-0031-15 C05-0030-15	CHIP C 0.022UF K CHIP C 1000PF K TRIMMING CAP (20P) TRIMMING CAP (10P) TRIMMING CAP (20P)		
- J1 J2 .3 J4 J5 .6 J7 J8 J9 .10 J11 J12 J13 J14 JP1 JP2 JP3 JP4 JP6 JP7 JP8 JP9 JP10,11 JP12,13 JP14,15 JP16 JP17			E04-0157-05 E40-3237-05 E40-3238-05 E40-3240-05 E40-3238-05 E40-3241-05 E40-3237-05 E40-3242-05 E40-3238-05 E40-3240-05 E40-3237-05 E40-3240-05 * E31-3157-05 * E31-1449-05 * E31-0302-05 E31-0381-05 E31-0381-05 * E31-1960-05 E31-1448-05 E31-1449-05 * E31-0302-05 * E31-3157-05 E31-0381-05 E31-0302-05 * E31-3157-05	MINI-PIN SOCKET PIN CONNECTOR (2P) PIN CONNECTOR (3P) PIN CONNECTOR (5P) PIN CONNECTOR (3P) PIN CONNECTOR (6P) PIN CONNECTOR (2P) PIN CONNECTOR (7P) PIN CONNECTOR (3P) PIN CONNECTOR (5P) PIN CONNECTOR (2P) PIN CONNECTOR (5P) CONNECTING WIRE(17.5MM) CONNECTING WIRE(7.5MM) CONNECTING WIRE(20MM) CONNECTING WIRE(10MM) CONNECTING WIRE(10MM) CONNECTING WIRE(15MM) CONNECTING WIRE(5MM) CONNECTING WIRE(7.5MM) CONNECTING WIRE(20MM) CONNECTING WIRE(17.5MM) CONNECTING WIRE(10MM) CONNECTING WIRE(20MM) CONNECTING WIRE(17.5MM)		

PARTS LIST

* New Parts

Parts without Parts No. are not supplied.

Les articles non mentionnés dans le Parts No. ne sont pas fournis.

Telle ohne Parts No. werden nicht geliefert.

Ref. No. 参照番号	Address 位置	New Parts 新	Parts No. 部品番号	Description 部品名 / 規格	Desti- nation 仕向	Re- marks 備考
JP18			E31-1960-05	CONNECTING WIRE(15MM)		
JP19,20			E31-0381-05	CONNECTING WIRE(10MM)		
JP21			E31-1449-05	CONNECTING WIRE(7.5MM)		
JP22,23			E31-0381-05	CONNECTING WIRE(10MM)		
JP24		*	E31-3157-05	CONNECTING WIRE(17.5MM)		
JP25		*	E31-0302-05	CONNECTING WIRE(20MM)		
JP26		*	E31-3157-05	CONNECTING WIRE(17.5MM)		
JP27		*	E31-1449-05	CONNECTING WIRE(7.5MM)		
JP28		*	E31-0302-05	CONNECTING WIRE(20MM)		
JP29		*	E31-1960-05	CONNECTING WIRE(15MM)		
JP30			E31-1449-05	CONNECTING WIRE(7.5MM)		
JP31			E31-0381-05	CONNECTING WIRE(10MM)		
JP32			E31-1449-05	CONNECTING WIRE(7.5MM)		
JP33,34			E31-0381-05	CONNECTING WIRE(10MM)		
JP35,36			E31-1449-05	CONNECTING WIRE(7.5MM)		
JP37			E31-1959-05	CONNECTING WIRE(12.5MM)		
TP2 -7			E23-0465-05	TERMINAL		
L1			L31-0313-05	COIL		
L4			L40-1092-16	SMALL FIXED INDUCTOR(1UH,5MM)		
L5			L34-0886-05	COIL		
L6			L31-0180-05	COIL		
L7 ,8			L31-0267-05	COIL		
L9			L34-2049-05	COIL		
L10			L40-1092-16	SMALL FIXED INDUCTOR(1UH,5MM)		
L11			L34-0894-05	COIL		
L14			L34-0894-05	COIL (Ø3,5T)		
L15			L34-0893-05	COIL (Ø3,4T)		
L16 ,17			L34-1025-05	COIL (Ø3,5.5T)		
L18			L34-2156-05	COIL		
L19 ,20			L34-2044-05	COIL		
L21			L34-2140-05	COIL		
L22			L40-6891-14	SMALL FIXED INDUCTOR(6.8UH)		
L23			L40-1011-14	SMALL FIXED INDUCTOR(100UH)		
L24			L30-0289-05	IFT		
L25			L40-3391-14	SMALL FIXED INDUCTOR(3.3UH)		
L26			L40-1011-14	SMALL FIXED INDUCTOR(100UH)		
L27		*	L33-0689-05	CHOKE COIL (5.6U)		
L28 ,29			L34-2155-05	COIL		
L30 ,31			L40-3311-14	SMALL FIXED INDUCTOR(330UH)		
L32 ,33			L40-1011-14	SMALL FIXED INDUCTOR(100UH)		
L34			L32-0675-05	OSCILLATING COIL		
L35			L40-3391-14	SMALL FIXED INDUCTOR(3.3UH)		
L36 -39			L40-1021-14	SMALL FIXED INDUCTOR(1MH)		
L40			L30-0281-15	IFT		
L41			L40-1511-14	SMALL FIXED INDUCTOR(150UH)		
L42			L40-1021-14	SMALL FIXED INDUCTOR(1MH)		
L43 ,44			L72-0336-05	CERAMIC FILTER		
L45 ,46			L40-1092-14	SMALL FIXED INDUCTOR(1UH)		
X1		*	L77-0720-05	CRYSTAL RESONATOR(10.24MHZ)		
X2			L77-1300-05	CRYSTAL RESONATOR(11.805MHZ)		
X3			L77-0857-05	CRYSTAL RESONATOR(10.6965MHZ)		
X4			L77-0856-05	CRYSTAL RESONATOR(10.6943MHZ)		
-			N15-1030-46	FLAT WASHER (FOR IC8)		
-			N35-3004-46	BL.HEAD MACHINE SCREW(FOR IC1)		

PARTS LIST

* New Parts

Parts without Parts No. are not supplied.

Les articles non mentionnés dans le Parts No. ne sont pas fournis.

Teile ohne Parts No. werden nicht geliefert.

Ref. No. 参照番号	Address 位置	New Parts 新	Parts No. 部品番号	Description 部品名 / 規格	Desti- nation 仕向	Re- marks 備考
-			N35-3006-46	BI. HEAD MACHINE SCREW (FOR IC8)		
JP38			R92-0150-05	JUMPER REST 0 OHM		
JR3 -9			R92-0670-05	CHIP R 0 OHM		
JR11-23		*	R92-0679-05	CHIP R 0 OHM		
JR24			R92-0670-05	CHIP R 0 OHM		
JR25-48		*	R92-0679-05	CHIP R 0 OHM		
JR49			R92-0670-05	CHIP R 0 OHM		
JR50		*	R92-0679-05	CHIP R 0 OHM		
R1			RK73FB2A100J	CHIP R 10 J 1/10W		
R2 ,3			RK73FB2A470J	CHIP R 47 J 1/10W		
R4 -6			RK73FB2A473J	CHIP R 47K J 1/10W		
R7			RK73FB2A470J	CHIP R 47 J 1/10W		
R8 -11			RK73FB2A473J	CHIP R 47K J 1/10W		
R12			RK73FB2A273J	CHIP R 27K J 1/10W		
R13		*	RK73FB2A561J	CHIP R 560 J 1/10W		
R14			RK73FB2A473J	CHIP R 47K J 1/10W		
R15			RK73FB2A101J	CHIP R 100 J 1/10W		
R16		*	RK73FB2A561J	CHIP R 560 J 1/10W		
R17			RK73FB2A222J	CHIP R 2.2K J 1/10W		
R18			RK73FB2A101J	CHIP R 100 J 1/10W		
R20			RK73FB2A152J	CHIP R 1.5K J 1/10W		
R21			RK73FB2A680J	CHIP R 68 J 1/10W		
R22			RK73FB2A100J	CHIP R 10 J 1/10W		
R23			RK73FB2A822J	CHIP R 8.2K J 1/10W		
R24			RK73FB2A103J	CHIP R 10K J 1/10W		
R25			RK73FB2A105J	CHIP R 1.0M J 1/10W		
R26 ,27			RK73FB2A103J	CHIP R 10K J 1/10W		
R28			RK73FB2A153J	CHIP R 15K J 1/10W		
R29			RK73FB2A822J	CHIP R 8.2K J 1/10W		
R30			RK73FB2A471J	CHIP R 470 J 1/10W		
R31			RK73FB2A124J	CHIP R 120K J 1/10W		
R32			RK73FB2A473J	CHIP R 47K J 1/10W		
R33			RK73FB2A124J	CHIP R 120K J 1/10W		
R34			RK73FB2A102J	CHIP R 1.0K J 1/10W		
R35			RK73FB2A104J	CHIP R 100K J 1/10W		
R36			RK73FB2A153J	CHIP R 15K J 1/10W		
R37			RK73FB2A272J	CHIP R 2.7K J 1/10W		
R38			RK73FB2A103J	CHIP R 10K J 1/10W		
R39			RK73FB2A153J	CHIP R 15K J 1/10W		
R40 ,41			RK73FB2A333J	CHIP R 33K J 1/10W		
R42			RK73FB2A153J	CHIP R 15K J 1/10W		
R43			RK73FB2A333J	CHIP R 33K J 1/10W		
R44			RK73FB2A124J	CHIP R 120K J 1/10W		
R45			RK73FB2A223J	CHIP R 22K J 1/10W		
R46			RK73FB2A473J	CHIP R 47K J 1/10W		
R47			RK73FB2A124J	CHIP R 120K J 1/10W		
R48			RK73FB2A104J	CHIP R 100K J 1/10W		
R49			RK73FB2A272J	CHIP R 2.7K J 1/10W		
R50			RK73FB2A560J	CHIP R 56 J 1/10W		
R51		*	RK73FB2A330J	CHIP R 33 J 1/10W		
R52			RK73FB2A680J	CHIP R 68 J 1/10W		
R53			RK73FB2A152J	CHIP R 1.5K J 1/10W		
R54		*	RK73FB2A561J	CHIP R 560 J 1/10W		
R55			RK73FB2A822J	CHIP R 8.2K J 1/10W		

PARTS LIST

× New Parts

Parts without Parts No. are not supplied.

Les articles non mentionnés dans le Parts No. ne sont pas fournis.

Telle ohne Parts No. werden nicht geliefert.

Ref. No. 参照番号	Address 位置	New Parts 新	Parts No. 部品番号	Description 部品名 / 規格	Desti- nation 仕向	Re- marks 備考
R56			RK73FB2A103J	CHIP R 10K J 1/10W		
R57 ,58			RK73FB2A333J	CHIP R 33K J 1/10W		
R59			RK73FB2A101J	CHIP R 100 J 1/10W		
R60			RK73FB2A152J	CHIP R 1.5K J 1/10W		
R61 ,62			RK73FB2A101J	CHIP R 100 J 1/10W		
R63		*	RK73FB2A561J	CHIP R 560 J 1/10W		
R64			RK73FB2A470J	CHIP R 47 J 1/10W		
R65		*	RK73FB2A561J	CHIP R 560 J 1/10W		
R66			RK73FB2A471J	CHIP R 470 J 1/10W		
R67			RK73FB2A474J	CHIP R 470K J 1/10W		
R68			RK73FB2A222J	CHIP R 2.2K J 1/10W		
R69			RK73FB2A221J	CHIP R 220 J 1/10W		
R70 ,71			RK73FB2A472J	CHIP R 4.7K J 1/10W		
R72			RK73FB2A560J	CHIP R 56 J 1/10W		
R73			RK73FB2A334J	CHIP R 330K J 1/10W		
R74			RK73FB2A472J	CHIP R 4.7K J 1/10W		
R75			RK73FB2A224J	CHIP R 220K J 1/10W		
R76			RK73FB2A152J	CHIP R 1.5K J 1/10W		
R77			RK73FB2A104J	CHIP R 100K J 1/10W		
R78			RK73FB2A154J	CHIP R 150K J 1/10W		
R79			RK73FB2A472J	CHIP R 4.7K J 1/10W		
R80			RK73FB2A223J	CHIP R 22K J 1/10W		
R81			RK73FB2A562J	CHIP R 5.6K J 1/10W		
R82			RK73FB2A682J	CHIP R 6.8K J 1/10W		
R83			RK73FB2A681J	CHIP R 680 J 1/10W		
R84		*	RK73FB2A561J	CHIP R 560 J 1/10W		
R85			RK73FB2A224J	CHIP R 220K J 1/10W		
R86			RK73FB2A221J	CHIP R 220 J 1/10W		
R87			RK73FB2A471J	CHIP R 470 J 1/10W		
R88 ,89			RK73FB2A223J	CHIP R 22K J 1/10W		
R90			RK73FB2A472J	CHIP R 4.7K J 1/10W		
R91			RK73FB2A222J	CHIP R 2.2K J 1/10W		
R92			RK73FB2A224J	CHIP R 220K J 1/10W		
R93			RK73FB2A470J	CHIP R 47 J 1/10W		
R94			RK73FB2A101J	CHIP R 100 J 1/10W		
R95			RK73FB2A332J	CHIP R 3.3K J 1/10W		
R96 ,97			RK73FB2A272J	CHIP R 2.7K J 1/10W		
R98			RK73FB2A101J	CHIP R 100 J 1/10W		
R99 ,100			RK73FB2A472J	CHIP R 4.7K J 1/10W		
R101			RK73FB2A101J	CHIP R 100 J 1/10W		
R102			RK73FB2A332J	CHIP R 3.3K J 1/10W		
R103			RK73FB2A333J	CHIP R 33K J 1/10W		
R104			RK73FB2A152J	CHIP R 1.5K J 1/10W		
R105			RK73FB2A101J	CHIP R 100 J 1/10W		
R106			RK73FB2A103J	CHIP R 10K J 1/10W		
R108			RK73FB2A223J	CHIP R 22K J 1/10W		
R109			RK73FB2A103J	CHIP R 10K J 1/10W		
R110		*	RK73FB2A561J	CHIP R 560 J 1/10W		
R111			RK73FB2A101J	CHIP R 100 J 1/10W		
R112			RK73FB2A124J	CHIP R 120K J 1/10W		
R113			RK73FB2A152J	CHIP R 1.5K J 1/10W		
R114			RK73FB2A682J	CHIP R 6.8K J 1/10W		
R115			RK73FB2A103J	CHIP R 10K J 1/10W		
R116			RK73FB2A101J	CHIP R 100 J 1/10W		
R117			RK73FB2A471J	CHIP R 470 J 1/10W		

PARTS LIST

* New Parts

Parts without Parts No. are not supplied.

Les articles non mentionnés dans le Parts No. ne sont pas fournis.

Teile ohne Parts No. werden nicht geliefert.

Ref. No. 参照番号	Address 位置	New Parts 新	Parts No. 部品番号	Description 部品名 / 規格	Desti- nation 仕向	Re- marks 備考
R118			RK73FB2A473J	CHIP R 47K J 1/10W		
R119			RK73FB2A101J	CHIP R 100 J 1/10W		
R120			RK73FB2A473J	CHIP R 47K J 1/10W		
R121			RK73FB2A101J	CHIP R 100 J 1/10W		
R122			RK73FB2A562J	CHIP R 5.6K J 1/10W		
R123,124			RK73FB2A332J	CHIP R 3.3K J 1/10W		
R125			RK73FB2A682J	CHIP R 6.8K J 1/10W		
R126			RK73FB2A223J	CHIP R 22K J 1/10W		
R127			RK73FB2A102J	CHIP R 1.0K J 1/10W		
R128			RK73FB2A473J	CHIP R 47K J 1/10W		
R129			RK73FB2A221J	CHIP R 220 J 1/10W		
R130		*	RK73FB2A330J	CHIP R 33 J 1/10W		
R131			RK73FB2A102J	CHIP R 1.0K J 1/10W		
R132			RK73FB2A101J	CHIP R 100 J 1/10W		
R133			RK73FB2A221J	CHIP R 220 J 1/10W		
R134			RK73FB2A224J	CHIP R 220K J 1/10W		
R135			RK73FB2A680J	CHIP R 68 J 1/10W		
R136			RK73FB2A102J	CHIP R 1.0K J 1/10W		
R137			RK73FB2A272J	CHIP R 2.7K J 1/10W		
R138			RK73FB2A562J	CHIP R 5.6K J 1/10W		
R139			RK73FB2A333J	CHIP R 33K J 1/10W		
R142			RK73FB2A221J	CHIP R 220 J 1/10W		
R143			RK73FB2A224J	CHIP R 220K J 1/10W		
VR1			R12-1429-05	TRIMMING PØT. (500)		
VR3			R12-3096-05	TRIMMING PØT. (10K)		KM1M2
VR3			R12-3443-05	TRIMMING PØT. (10K)		TW
VR4			R12-1430-05	TRIMMING PØT. (3K)		
VR5 .6			R12-4413-05	TRIMMING PØT. (50K)		
VR7		*	R12-6012-05	TRIMMING PØT. (470K)		
VR8			R12-2413-05	TRIMMING PØT. (5K)		
D1 -5			BB221	VARI CAP		
D6			1SS133	DIØDE		
D9			1N60PSPA	DIØDE		
D10 .11			1SS133	DIØDE		
D12			DAN202K	CHIP DIØDE		
D12			1SS184	CHIP DIØDE		
D13			1SS133	DIØDE		
D14 .15			MA856	DIØDE		
D16 .17			1SV153	DIØDE		
D18 -20			MA856	DIØDE		
IC1			MB3712	IC(AF POWER AMP)		
IC2			SN16913P	IC(DUBLE BALANCED MIXERS)		
IC3			TA7310P	IC(PLL)		
IC4			TC5082P-G	IC		
IC5		*	TC74HC390P	IC		
IC6 .7		*	TC9172P	IC		
IC8		*	L78N08	IC		
Q1 .2			2SK161(GR)	FET		
Q3			3SK74(L)	FET		
Q4			2SC2026	TRANSISTØR		
Q5			2SC2538-22-A	TRANSISTØR		
Q7			2SC2712(Y)	CHIP TRANSISTØR		
Q8		*	DTC143EK	DIGITAL TRANSISTØR		
Q9			2SC2712(Y)	TRANSISTØR		
Q10		*	DTA143EK	DIGITAL TRANSISTØR		

PARTS LIST

* New Parts

Parts without Parts No. are not supplied.

Les articles non mentionnés dans le Parts No. ne sont pas fournis.

Teile ohne Parts No. werden nicht geliefert.

Ref. No. 参照番号	Address 位置	New Parts 新	Parts No. 部品番号	Description 部品名 / 規格	Desti- nation 仕 向	Re- marks 備考
Q11			2SA1162(Y)	CHIP TRANSISTOR		
Q12		*	DTA143EK	DIGITAL TRANSISTOR		
Q13			2SC2714(Y)	CHIP TRANSISTOR		
Q14			3SK73(GR)	FET		
Q15			2SC2712(Y)	CHIP TRANSISTOR		
Q16		*	DTA143EK	DIGITAL TRANSISTOR		
Q17			2SC2712(Y)	CHIP TRANSISTOR		
Q18 ,19			2SC2714(Y)	CHIP TRANSISTOR		
Q20		*	2SC2715(Y)	CHIP TRANSISTOR		
Q21			2SC2714(Y)	CHIP TRANSISTOR		
Q22 -24		*	2SC3324(G,B)	CHIP TRANSISTOR		
Q25		*	DTA143EK	DIGITAL TRANSISTOR		
Q26			DTC144EK	DIGITAL TRANSISTOR		
Q27 -29		*	2SC3324(G,B)	CHIP TRANSISTOR		
Q30 ,31			2SC2714(Y)	CHIP TRANSISTOR		
Q32			2SC2712(Y)	CHIP TRANSISTOR		
Q33			DTC144EK	DIGITAL TRANSISTOR		
Q34 -36			2SC2714(Y)	CHIP TRANSISTOR		
-		*	X58-1000-00	SUB UNIT (VCO)	TW	
-		*	X58-1000-11	SUB UNIT (VCO)	KM1M2	
-		*	X59-1130-00	MODULE UNIT (CW BRAKE IN)		
COMPOSITE UNIT (RX) (X60-1320-XX) -00 : W,T -11 : K,M1,M2						
C1			CC73FCH1H040C	CHIP C 4.0PF C		
C2			C90-0868-05	ELECTRØ 10UF 16WV		
C3			CK73FB1E223K	CHIP C 0.022UF K		
C4			CC73FCH1H470J	CHIP C 47PF J		
C5			CK73FB1E223K	CHIP C 0.022UF K		
C6			CC73FSL1H101J	CHIP C 100PF J		
C7 -9			CK73FB1E223K	CHIP C 0.022UF K		
C10			CK73FB1H102K	CHIP C 1000PF K		
C11 -16			CK73FB1E223K	CHIP C 0.022UF K		
C17			CC73FCH1H470J	CHIP C 47PF J		
C18 ,19			CK73FB1E223K	CHIP C 0.022UF K		
C20			CC73FCH1H100D	CHIP C 10PF D		
C21			CK73FB1E223K	CHIP C 0.022UF K		
C22			CK73EB1H103K	CHIP C 0.010UF K		*1,2
C22			CK73FB1H103K	CHIP C 0.010UF K		*3
C23			CC73FCH1H100D	CHIP C 10PF D		*1,2
C23			CC73FCH1H220J	CHIP C 22PF J		*3
C24		*	CK73EB1H273K	CHIP C 0.027UF K		
C25 -28			CK73FB1E223K	CHIP C 0.022UF K		
C29			CK73FB1H471K	CHIP C 470PF K		
C30			CK73FB1E223K	CHIP C 0.022UF K		
C31			CK73FB1H103K	CHIP C 0.010UF K		
C32			CC73FCH1H150J	CHIP C 15PF J		
C33 -35			CK73FB1E223K	CHIP C 0.022UF K		
C36			C90-0868-05	ELECTRØ 10UF 16WV		
C37			CC73FSL1H331J	CHIP C 330PF J		
C38			CK73FB1E223K	CHIP C 0.022UF K		
C39			CS15E1E010M	TANTAL 1.0UF 25WV		
C40			CK73FB1E223K	CHIP C 0.022UF K		
C41 ,42			CK73FB1H102K	CHIP C 1000PF K		
C43			CK73FB1H103K	CHIP C 0.010UF K		
C44			CK73FB1E223K	CHIP C 0.022UF K		

*1 : S/No. 705-707XXXX (W,T)

*2 : S/No. 705-707XXXX (K,M1,M2)

*3 : S/No. 708XXXX- (K,M1,M2,W,T)

PARTS LIST

* New Parts

Parts without Parts No. are not supplied.

Les articles non mentionnés dans le Parts No. ne sont pas fournis.

Teile ohne Parts No. werden nicht geliefert.

Ref. No. 参照番号	Address 位置	New Parts 新	Parts No. 部品番号	Description 部品名 / 規格	Desti- nation 仕 向	Re- marks 備考
C45			CC73FSL1H101J	CHIP C 100PF J		
C46 .47			CK73FB1E223K	CHIP C 0.022UF K		
C48			CK73FB1H103K	CHIP C 0.010UF K		
C49			CK73FB1E223K	CHIP C 0.022UF K		
C50			CE04W1A470M	ELECTRØ 47UF 10WV		
C51 .52			CF92V1H104J	MF 0.10UF J	*1,2	
C51 .52			CK73EB1E104K	CHIP C 0.10UF K		*3
C53			CC73FCH1H030C	CHIP C 3.0PF C		
C54			CK73FB1H102K	CHIP C 1000PF K		
C55 .56			CF92V1H104J	MF 0.10UF J	*1,2	
C55 .56			CK73EB1E104K	CHIP C 0.10UF K		*3
C57 .58			CK73FB1H102K	CHIP C 1000PF K		
C59			CC73FCH1H220J	CHIP C 22PF J		
C60			CK73FB1H472K	CHIP C 4700PF K		
C61			CK73FB1H472K	CHIP C 4700PF K		*3
C61			CK73FB1H102K	CHIP C 1000PF K		*1,2
C62			CC73FCH1H220J	CHIP C 22PF J		
C63			CK73FB1H102K	CHIP C 1000PF K		
C64			CK73EB1E473K	CHIP C 0.047UF K		
C65			CC73FSL1H121J	CHIP C 120PF J		
C66			CK73FB1H472K	CHIP C 4700PF K		
C67			CK73EB1E104K	CHIP C 0.10UF K		*3
C67			C90-0824-05	ELECTRØ 1UF 50WV		*1,2
C68			CK73FB1E223K	CHIP C 0.022UF K		
C69			CK73EB1E473K	CHIP C 0.047UF K		
C70 .71			CK73FB1E223K	CHIP C 0.022UF K		
C72			CC73FSL1H331J	CHIP C 330PF J		
C73			CC73FCH1H470J	CHIP C 47PF J		
C74			CK73FB1E223K	CHIP C 0.022UF K		
C75			CC73FCH1H470J	CHIP C 47PF J		
C76			CC73FCH1H030C	CHIP C 3.0PF C		
C77			CS15E1E010M	TANTAL 1.0UF 25WV		
C78 .79			CK73FB1H102K	CHIP C 1000PF K		
C80			CE04W1A470M	ELECTRØ 47UF 10WV		
C81			C90-0478-05	ELECTRØ 10UF 16WV		
C82			C90-0824-05	ELECTRØ 1UF 50WV		
C83			CK73FB1H102K	CHIP C 1000PF K		
C84			CC45UJ1H020C	CERAMIC 2.0PF C		
C85			CC45UJ1H100D	CERAMIC 10PF D		
C86			CK73FB1H103K	CHIP C 0.010UF K		
C87 .88			CC73FSL1H221J	CHIP C 220PF J		
C89			CK73FB1H103K	CHIP C 0.010UF K		
C90			CC73FCH1H030C	CHIP C 3.0PF C		
C91			CC73FCH1H050C	CHIP C 5.0PF C		
C92			CC73FCH1H470J	CHIP C 47PF J		
C93 -95			CK73FB1E223K	CHIP C 0.022UF K		
C96			CK73FB1H102K	CHIP C 1000PF K		
C97 .98			CC73FSL1H101J	CHIP C 100PF J		
C99			CK73FB1H102K	CHIP C 1000PF K		
C100			CC73FSL1H101J	CHIP C 100PF J		
C101			CE04W1A470M	ELECTRØ 47UF 10WV		
C102			C90-0824-05	ELECTRØ 1UF 50WV		
C103			C90-0478-05	ELECTRØ 10UF 16WV		
C104			CK73FB1H103K	CHIP C 0.010UF K		
C105.106			C90-0824-05	ELECTRØ 1UF 50WV		

*1 : S/No. 705-707XXXX (W,T)

*2 : S/No. 705-707XXXX (K,M1,M2)

*3 : S/No. 708XXXX- (K,M1,M2,W,T)

PARTS LIST

× New Parts

Parts without Parts No. are not supplied.

Les articles non mentionnés dans le Parts No. ne sont pas fournis.

Teile ohne Parts No. werden nicht geliefert.

Ref. No. 参照番号	Address 位置	New Parts 新	Parts No. 部品番号	Description 部品名 / 規格	Desti- nation 仕向	Re- marks 備考
C107			CK73FB1H103K	CHIP C 0.010UF K		
C108			CE04W1A470M	ELECTR0 47UF 10WV		
C109			C90-0478-05	ELECTR0 10UF 16WV		
C110			C90-0824-05	ELECTR0 1UF 50WV		
C111			CK73FB1H103K	CHIP C 0.010UF K		
C112			CK73FB1H102K	CHIP C 1000PF K		
C113			CK73FB1E223K	CHIP C 0.022UF K		
C114			CE04CW1A330M	ELECTR0 33UF 10WV		*3
C114			CE04W1A470M	ELECTR0 47UF 10WV		*1,2
C115			CK73FB1E223K	CHIP C 0.022UF K		
C116-118			CK73FB1H103K	CHIP C 0.010UF K		
C119			CC73FCH1H470J	CHIP C 47PF J		
C120			CK73FB1E223K	CHIP C 0.022UF K		
C121			CC73FCH1H470J	CHIP C 47PF J		
C122			CC73FCH1H050C	CHIP C 5.0PF C		
C123,124			CK73FB1E223K	CHIP C 0.022UF K		
C125			CK73FB1H103K	CHIP C 0.010UF K		
C126,127			CK73FB1H102K	CHIP C 1000PF K		
C128		*	C90-2033-05	ELECTR0 1000UF 16WV		
C129			CK73FB1E223K	CHIP C 0.022UF K		
C130			CK73FB1H102K	CHIP C 1000PF K		
C131,132			CK73FB1H103K	CHIP C 0.010UF K		
C133			CE04W1A470M	ELECTR0 47UF 10WV		
C134			C90-0478-05	ELECTR0 10UF 16WV		
C135			CE04W1C101M	ELECTR0 100UF 16WV		
C136			C90-0820-05	ELECTR0 470UF 16WV		
C137			CE04W1C470M	ELECTR0 47UF 16WV		*1,2
C137			CE04CW1C470M	ELECTR0 47UF 16WV		*3
C138,139			CE04W1C330M	ELECTR0 33UF 16WV		
C138,139			CE04W1C330M	ELECTR0 33UF 16WV		
C140,141			CK73FB1H103K	CHIP C 0.010UF K		
C142			CS15E1C2R2M	TANTAL 2.2UF 16WV		
C143			CS15E1C4R7M	TANTAL 4.7UF 16WV		
C144			CS15E1C100M	TANTAL 10UF 16WV		
C145			C90-0868-05	ELECTR0 10UF 16WV		
C146			C90-0478-05	ELECTR0 10UF 16WV		
C147			CK73EB1E473K	CHIP C 0.047UF K		
C148			CE04W1A470M	ELECTR0 47UF 10WV		
C149			C90-0824-05	ELECTR0 1UF 50WV		*1,2
C149,150			CK73EB1E104K	CHIP C 0.10UF K		*3
C150			CS15E1V0R1M	TANTAL 0.1UF 35WV		*1,2
C151			CE04W1C100M	ELECTR0 10UF 16WV		*1,2
C151			C90-0478-05	ELECTR0 10UF 16WV		*3
C152			CK73FB1H102K	CHIP C 1000PF K		
C153			CK73FB1H103K	CHIP C 0.010UF K		
C154			CK73FB1H471K	CHIP C 470PF K		
C155-157			CK73FB1E223K	CHIP C 0.022UF K		
C158			CK73FB1H471K	CHIP C 470PF K		
C159			CK73FB1E223K	CHIP C 0.022UF K		*3
C201			CC73FRH1H120J	CHIP C 12PF J		
C202			CC73FCH1H330J	CHIP C 33PF J		
C203			CC73FCH1H030C	CHIP C 3.0PF C		
C204,205			CC73FRH1H180J	CHIP C 18PF J		
C206			CK73FB1E223K	CHIP C 0.022UF K		
C207-210			CK73FB1H102K	CHIP C 1000PF K		

*1 : S/No. 705-707XXXX (W,T)

*2 : S/No. 705-707XXXX (K,M1,M2)

*3 : S/No. 708XXXX- (K,M1,M2,W,T)

PARTS LIST

× New Parts

Parts without Parts No. are not supplied.

Les articles non mentionnés dans le Parts No. ne sont pas fournis.

Teile ohne Parts No. werden nicht geliefert.

Ref. No. 参照番号	Address 位置	New Parts 新	Parts No. 部品番号	Description 部品名/規格	Desti- nation 仕向	Re- marks 備考
C211			CC73FCH1H330J	CHIP C 33PF J		
C212			CK73FB1H102K	CHIP C 1000PF K		
C213			CC73FCH1H030C	CHIP C 3.0PF C		
C214			CC73FCH1H070D	CHIP C 7.0PF D		
C215			CC73FCH1H010C	CHIP C 1.0PF C		
C216,217			CK73FB1H103K	CHIP C 0.010UF K		
C218			CK73FB1E223K	CHIP C 0.022UF K		
C219			CC73FCH1H050C	CHIP C 5.0PF C		
TC1			C05-0030-15	TRIMMING CAP (20P)		
TC2			C05-0062-05	TRIMMING CAP (6P)		
J1			E40-3240-05	PIN CONNECTOR (5P)EH		
J2			E40-3238-05	PIN CONNECTOR (3P)EH		
J3			E40-3241-05	PIN CONNECTOR (6P)EH		
J4		*	E40-5067-05	PIN CONNECTOR (10P)EH		
J5			E40-3242-05	PIN CONNECTOR (7P)EH		
J6			E40-3238-05	PIN CONNECTOR (3P)EH		
J7			E40-3241-05	PIN CONNECTOR (6P)EH		
J8 ,9			E40-3237-05	PIN CONNECTOR (2P)EH		
J10 ,11			E40-3241-05	PIN CONNECTOR (6P)EH		
J12			E40-3237-05	PIN CONNECTOR (2P)EH		
J13			E40-0273-05	PIN CONNECTOR (TL-25)SP		
J20			E40-3237-05	PIN CONNECTOR (2P)EH		
J202			E40-3237-05	PIN CONNECTOR (2P)EH		
JP1			E31-0381-05	CONNECTING WIRE(10MM)		
JP2		*	E31-0302-05	CONNECTING WIRE(20MM)		
JP3			E31-0381-05	CONNECTING WIRE(10MM)		
JP4		*	E31-0302-05	CONNECTING WIRE(20MM)		
JP5		*	E31-1960-05	CONNECTING WIRE(15MM)		
JP6			E31-0381-05	CONNECTING WIRE(10MM)		
JP7		*	E31-0302-05	CONNECTING WIRE(20MM)		
JP8 -11		*	E31-1960-05	CONNECTING WIRE(15MM)		
JP12,13		*	E31-0302-05	CONNECTING WIRE(20MM)		
JP14			E31-0381-05	CONNECTING WIRE(10MM)		
JP15		*	E31-0302-05	CONNECTING WIRE(20MM)		
JP16		*	E31-1960-05	CONNECTING WIRE(15MM)		
JP17			E31-1449-05	CONNECTING WIRE(7.5MM)		
JP18			E31-0381-05	CONNECTING WIRE(10MM)		
JP18			E31-1959-05	CONNECTING WIRE(12.5MM)		
JP19		*	E31-1960-05	CONNECTING WIRE(15MM)		*1,2
JP20			E31-1449-05	CONNECTING WIRE(7.5MM)		*3
JP21			E31-0381-05	CONNECTING WIRE(10MM)		
JP22,23		*	E31-1960-05	CONNECTING WIRE(15MM)		
JP24		*	E31-0302-05	CONNECTING WIRE(20MM)		
JP25			E31-1449-05	CONNECTING WIRE(7.5MM)		
JP26		*	E31-0302-05	CONNECTING WIRE(20MM)		
JP201			E31-0381-05	CONNECTING WIRE(10MM)		
JP202,203		*	E31-0302-05	CONNECTING WIRE(20MM)		
TP1 -4			E23-0465-05	TERMINAL		
TP201			E40-0211-05	PIN CONNECTOR (2P)		
CF1			L72-0315-05	CERAMIC FILTER (CFW455F)		
L1 -7			L30-0281-15	IFT		
L8			L30-0503-05	IFT		
L9			L40-4791-14	SMALL FIXED INDUCTOR(4.7U)		
L10			L30-0503-05	IFT		

*1 : S/No. 705-707XXXX (W,T)

*2 : S/No. 705-707XXXX (K,M1,M2)

*3 : S/No. 708XXXX- (K,M1,M2,W,T)

PARTS LIST

× New Parts

Parts without Parts No. are not supplied.

Les articles non mentionnés dans le Parts No. ne sont pas fournis.

Telle ohne Parts No. werden nicht geliefert.

Ref. No. 参照番号	Address 位置	New Parts 新	Parts No. 部品番号	Description 部品名 / 規格	Desti- nation 仕向	Re- marks 備考
L11			L40-1021-14	SMALL FIXED INDUCTOR(1MH)	*1,2	
L12			L40-1021-14	SMALL FIXED INDUCTOR(1MH)		
L13			L30-0503-05	IFT		
L14			L40-1021-14	SMALL FIXED INDUCTOR(1MH)		
L15			L30-0503-05	IFT		
L16 ,17			L40-1021-14	SMALL FIXED INDUCTOR(1MH)		
L18		*	L33-0691-05	CHOKe COIL (15U)		
L19			L40-1011-16	SMALL FIXED INDUCTOR(100U)		
L20			L40-1011-14	SMALL FIXED INDUCTOR(100U)		
L21			L30-0515-05	IFT		
L22			L15-0306-05	LOW-FREQUENCY CHOKe COIL	TW KM1M2	
L23			L40-1021-14	SMALL FIXED INDUCTOR(1MH)		
L201,202			L31-0267-05	COIL		
L203			L79-0498-15	HELICAL RESONATOR		
L203			L79-0499-05	HELICAL RESONATOR		
L204			L34-0683-05	COIL		
L205			L40-1092-16	SMALL FIXED INDUCTOR(1U)		
L206,207			L30-0005-05	IFT		
L208			L40-1021-14	SMALL FIXED INDUCTOR(1MH)		
X1		*	L77-1305-05	CRYSTAL RESONATOR		
XF1			L71-0249-05	CRYSTAL FILTER (10F2.2S)		
XF201			L71-0216-05	MCF (10.695)		
-			N35-3006-46	BINDING HEAD MACHINE SCREW		
JR1 -4			R92-0670-05	CHIP R 0 OHM	*1,2 *3	
JR5			R92-0670-05	CHIP R 0 OHM		
JR5		*	R92-0679-05	CHIP R 0 OHM		
JR6 ,7			R92-0670-05	CHIP R 0 OHM		
JR9 -13			R92-0670-05	CHIP R 0 OHM		
JR50-58		*	R92-0679-05	CHIP R 0 OHM	*1,2 *3 *1,2	
JR59		*	R92-0679-05	CHIP R 0 OHM		
JR60,61			R92-0670-05	CHIP R 0 OHM		
JR60,61		*	R92-0679-05	CHIP R 0 OHM		
JR62-76		*	R92-0679-05	CHIP R 0 OHM		
JR77		*	R92-0679-05	CHIP R 0 OHM	*3	
JR250,251		*	R92-0679-05	CHIP R 0 OHM		
R1		*	RK73FB2A102J	CHIP R 1.0K J 1/10W		
R2			RK73FB2A103J	CHIP R 10K J 1/10W		
R3			RK73FB2A273J	CHIP R 27K J 1/10W		
R4			RK73FB2A105J	CHIP R 1.0M J 1/10W		
R5			RK73FB2A331J	CHIP R 330 J 1/10W		
R6			RK73FB2A101J	CHIP R 100 J 1/10W		
R7 -10			RK73FB2A332J	CHIP R 3.3K J 1/10W		
R11			RK73FB2A103J	CHIP R 10K J 1/10W		
R12			RK73FB2A102J	CHIP R 1.0K J 1/10W		
R14			RK73FB2A331J	CHIP R 330 J 1/10W		
R15			RK73FB2A223J	CHIP R 22K J 1/10W		
R16		*	RK73EB2B101J	CHIP R 100 J 1/8W		
R17			RK73FB2A103J	CHIP R 10K J 1/10W		
R18			RK73FB2A102J	CHIP R 1.0K J 1/10W		
R20			RK73FB2A331J	CHIP R 330 J 1/10W		
R21			RK73FB2A472J	CHIP R 4.7K J 1/10W		
R22		*	RK73EB2B101J	CHIP R 100 J 1/8W		
R23 ,24			RK73FB2A471J	CHIP R 470 J 1/10W		

*1 : S/No. 705-707XXXX (W,T)

*2 : S/No. 705-707XXXX (K,M1,M2)

*3 : S/No. 708XXXX- (K,M1,M2,W,T)

PARTS LIST

× New Parts

Parts without Parts No. are not supplied.

Les articles non mentionnés dans le Parts No. ne sont pas fournis.

Teile ohne Parts No. werden nicht geliefert.

Ref. No. 参照番号	Address 位置	New Parts 新	Parts No. 部品番号	Description 部品名/規格	Desti- nation 仕向	Re- marks 備考
R25			RK73FB2A562J	CHIP R 5.6K J 1/10W		
R26			RK73FB2A472J	CHIP R 4.7K J 1/10W		
R27 ,28			RK73FB2A153J	CHIP R 15K J 1/10W		
R29			RK73FB2A105J	CHIP R 1.0M J 1/10W		
R30			RK73FB2A102J	CHIP R 1.0K J 1/10W		
R31			RK73FB2A101J	CHIP R 100 J 1/10W		
R32			RK73FB2A223J	CHIP R 22K J 1/10W		
R33			RK73FB2A682J	CHIP R 6.8K J 1/10W		
R34			RK73FB2A681J	CHIP R 680 J 1/10W		
R35			RK73FB2A102J	CHIP R 1.0K J 1/10W		
R36			RK73FB2A473J	CHIP R 47K J 1/10W		
R37			RK73FB2A101J	CHIP R 100 J 1/10W		
R38			RK73FB2A333J	CHIP R 33K J 1/10W		
R39			RK73FB2A103J	CHIP R 10K J 1/10W		
R40			RK73FB2A182J	CHIP R 1.8K J 1/10W		
R41			RK73FB2A103J	CHIP R 10K J 1/10W		
R43			RK73FB2A392J	CHIP R 3.9K J 1/10W		
R44 ,45			RK73FB2A102J	CHIP R 1.0K J 1/10W		
R46			RK73FB2A682J	CHIP R 6.8K J 1/10W		
R47			RK73FB2A182J	CHIP R 1.8K J 1/10W		
R48			RK73FB2A473J	CHIP R 47K J 1/10W		
R49			RK73FB2A333J	CHIP R 33K J 1/10W		
R50 ,51			RK73FB2A224J	CHIP R 220K J 1/10W		
R52			RK73FB2A473J	CHIP R 47K J 1/10W		
R53			RK73FB2A103J	CHIP R 10K J 1/10W	*3	
R53			RK73FB2A123J	CHIP R 12K J 1/10W		*1,2
R54			RK73FB2A153J	CHIP R 15K J 1/10W		
R55			RK73FB2A105J	CHIP R 1.0M J 1/10W		
R56			RK73FB2A823J	CHIP R 82K J 1/10W		
R57			RK73FB2A473J	CHIP R 47K J 1/10W		
R58			RK73FB2A334J	CHIP R 330K J 1/10W		
R59			RK73FB2A224J	CHIP R 220K J 1/10W		
R60			RK73FB2A103J	CHIP R 10K J 1/10W		
R61			RK73FB2A332J	CHIP R 3.3K J 1/10W		
R62			RK73FB2A102J	CHIP R 1.0K J 1/10W		
R63			RK73FB2A104J	CHIP R 100K J 1/10W		
R64			RK73FB2A681J	CHIP R 680 J 1/10W		
R65			RK73FB2A222J	CHIP R 2.2K J 1/10W		
R66			RK73FB2A334J	CHIP R 330K J 1/10W		
R67			RK73FB2A103J	CHIP R 10K J 1/10W		
R68			RK73FB2A104J	CHIP R 100K J 1/10W		
R69			RK73FB2A333J	CHIP R 33K J 1/10W		
R70			RK73FB2A105J	CHIP R 1.0M J 1/10W		
R71			RK73FB2A103J	CHIP R 10K J 1/10W		
R72			RK73FB2A224J	CHIP R 220K J 1/10W		
R73			RK73FB2A152J	CHIP R 1.5K J 1/10W		
R74			RK73FB2A152J	CHIP R 1.5K J 1/10W		*1,2
R74			RK73FB2A222J	CHIP R 2.2K J 1/10W		*3
R75			RK73FB2A682J	CHIP R 6.8K J 1/10W		
R76			RK73FB2A105J	CHIP R 1.0M J 1/10W		
R77			RK73FB2A273J	CHIP R 27K J 1/10W		
R78			RK73FB2A334J	CHIP R 330K J 1/10W		
R79			RK73FB2A101J	CHIP R 100 J 1/10W		
R80			RK73FB2A273J	CHIP R 27K J 1/10W		
R81			RK73FB2A683J	CHIP R 68K J 1/10W		

*1 : S/No. 705-707XXXX (W,T)

*2 : S/No. 705-707XXXX (K,M1,M2)

*3 : S/No. 708XXXX- (K,M1,M2,W,T)

PARTS LIST

× New Parts

Parts without Parts No. are not supplied.

Les articles non mentionnés dans le Parts No. ne sont pas fournis.

Telle ohne Parts No. werden nicht geliefert.

Ref. No. 参照番号	Address 位置	New Parts 新	Parts No. 部品番号	Description 部品名 / 規格	Desti- nation 仕向	Re- marks 備考
R82			RK73FB2A103J	CHIP R 10K J 1/10W		
R83			RK73FB2A183J	CHIP R 18K J 1/10W		
R84			RK73FB2A102J	CHIP R 1.0K J 1/10W		
R85			RK73FB2A104J	CHIP R 100K J 1/10W		
R86			RK73FB2A101J	CHIP R 100 J 1/10W		
R87			RK73FB2A331J	CHIP R 330 J 1/10W		
R88			RK73FB2A152J	CHIP R 1.5K J 1/10W		
R89			RK73FB2A103J	CHIP R 10K J 1/10W		
R90			RK73FB2A472J	CHIP R 4.7K J 1/10W		
R91			RK73FB2A103J	CHIP R 10K J 1/10W		
R92			RK73FB2A473J	CHIP R 47K J 1/10W		
R93			RK73FB2A103J	CHIP R 10K J 1/10W		
R94			RK73FB2A102J	CHIP R 1.0K J 1/10W		
R95			RK73FB2A223J	CHIP R 22K J 1/10W		
R96			RK73FB2A101J	CHIP R 100 J 1/10W		
R97			RK73FB2A472J	CHIP R 4.7K J 1/10W		
R98			RK73FB2A102J	CHIP R 1.0K J 1/10W		
R99			RK73FB2A104J	CHIP R 100K J 1/10W		
R100			RK73FB2A223J	CHIP R 22K J 1/10W		
R101			RK73EB2B101J	CHIP R 100 J 1/8W		
R102			RK73FB2A472J	CHIP R 4.7K J 1/10W		
R103			RK73FB2A101J	CHIP R 100 J 1/10W		
R104			RK73FB2A102J	CHIP R 1.0K J 1/10W		
R105			RK73FB2A473J	CHIP R 47K J 1/10W		*1
R105			R92-0670-05	CHIP R 0 OHM		*2
R106			RK73FB2A471J	CHIP R 470 J 1/10W		*1
R107			RK73FB2A473J	CHIP R 47K J 1/10W		
R108			RK73FB2A223J	CHIP R 22K J 1/10W		
R109		*	RK73EB2B101J	CHIP R 100 J 1/8W		
R110			RK73FB2A222J	CHIP R 2.2K J 1/10W		
R111			RK73FB2A221J	CHIP R 220 J 1/10W		
R112			RK73FB2A102J	CHIP R 1.0K J 1/10W		
R113			RK73FB2A471J	CHIP R 470 J 1/10W		
R114			RK73FB2A224J	CHIP R 220K J 1/10W		
R115		*	RK73EB2B101J	CHIP R 100 J 1/8W		
R116			RK73FB2A473J	CHIP R 47K J 1/10W		
R117			RK73FB2A222J	CHIP R 2.2K J 1/10W		
R118			RK73FB2A332J	CHIP R 3.3K J 1/10W		
R119,120			RK73FB2A152J	CHIP R 1.5K J 1/10W		
R121,122			RK73FB2A101J	CHIP R 100 J 1/10W		
R123			RK73FB2A472J	CHIP R 4.7K J 1/10W		
R124			RK73FB2A102J	CHIP R 1.0K J 1/10W		
R125			RK73FB2A473J	CHIP R 47K J 1/10W		
R127			RK73FB2A103J	CHIP R 10K J 1/10W		
R128			RK73FB2A222J	CHIP R 2.2K J 1/10W		
R129			RK73FB2A103J	CHIP R 10K J 1/10W		
R132			RK73FB2A102J	CHIP R 1.0K J 1/10W		
R133			RK73FB2A472J	CHIP R 4.7K J 1/10W		
R134			RK73FB2A152J	CHIP R 1.5K J 1/10W		
R135			RK73FB2A102J	CHIP R 1.0K J 1/10W		
R136			RS14KB3D330J	FL-PROOF RS 33 J 2W		
R138			RK73FB2A221J	CHIP R 220 J 1/10W		
R139			RK73FB2A333J	CHIP R 33K J 1/10W		
R140			RK73FB2A103J	CHIP R 10K J 1/10W		
R141			RK73FB2A332J	CHIP R 3.3K J 1/10W		

*1 : S/No. 705-707XXXX (W,T)

*2 : S/No. 705-707XXXX (K,M1,M2)

*3 : S/No. 708XXXX- (K,M1,M2,W,T)

PARTS LIST

* New Parts

Parts without Parts No. are not supplied.

Les articles non mentionnés dans le Parts No. ne sont pas fournis.

Telle ohne Parts No. werden nicht geliefert.

Ref. No. 参照番号	Address 位置	New Parts 新	Parts No. 部品番号	Description 部品名 / 規格	Desti- nation 仕 向	Re- marks 備考
R142			RK73FB2A101J	CHIP R 100. J 1/10W		
R143			RK73FB2A562J	CHIP R 5.6K J 1/10W		
R144			RK73FB2A102J	CHIP R 1.0K J 1/10W		
R145			RK73FB2A473J	CHIP R 47K J 1/10W		
R146			RK73FB2A222J	CHIP R 2.2K J 1/10W		
R147			RK73FB2A102J	CHIP R 1.0K J 1/10W		
R148			RK73FB2A103J	CHIP R 10K J 1/10W		
R149			RK73FB2A333J	CHIP R 33K J 1/10W		
R150			RK73FB2A102J	CHIP R 1.0K J 1/10W		
R201			RK73FB2A223J	CHIP R 22K J 1/10W		*3
R202			RK73FB2A104J	CHIP R 100K J 1/10W		
R203			RK73FB2A101J	CHIP R 100 J 1/10W		
R204			RK73FB2A470J	CHIP R 47 J 1/10W		
R205			RK73FB2A152J	CHIP R 1.5K J 1/10W		
R206			RK73FB2A470J	CHIP R 47 J 1/10W		
R208			RK73FB2A122J	CHIP R 1.2K J 1/10W		TW
R208			RK73FB2A152J	CHIP R 1.5K J 1/10W		KM1M2
R209,210			RK73FB2A473J	CHIP R 47K J 1/10W		
R211			RK73FB2A470J	CHIP R 47 J 1/10W		
R212			RK73FB2A224J	CHIP R 220K J 1/10W		*3
R212		*	RK73FB2A274J	CHIP R 270K J 1/10W		*1,2
R213			RK73FB2A100J	CHIP R 10 J 1/10W		
R214		*	RK73EB2B101J	CHIP R 100 J 1/8W		
R215			RK73FB2A102J	CHIP R 1.0K J 1/10W		
R216			RK73FB2A473J	CHIP R 47K J 1/10W		*3
VR1			R12-3450-05	TRIMMING PØT. (20K)		
VR2		*	R12-1435-05	TRIMMING PØT. (2K)		
VR3			R12-3443-05	TRIMMING PØT. (10K)		
VR4			R12-7408-05	TRIMMING PØT. (500K)		
VR5 .6			R12-3450-05	TRIMMING PØT. (20K)		
VR7			R12-3443-05	TRIMMING PØT. (10K)		
VR8			R12-2413-05	TRIMMING PØT. (5K)		
VR9			R12-3443-05	TRIMMING PØT. (10K)		
VR10			R12-5420-05	TRIMMING PØT. (100K)		
VR11			R12-3443-05	TRIMMING PØT. (10K)		
VR12			R12-2413-05	TRIMMING PØT. (5K)		
VR13			R12-1428-05	TRIMMING PØT. (1K)		
VR14			R12-3443-05	TRIMMING PØT. (10K)		
D1		*	1SS272	CHIP DIØDE		*3
D1 .2			1S1587	DIØDE		*1,2
D3 .4			DAN202(K)	CHIP DIØDE		*1,2
D3 .4			1SS184	CHIP DIØDE		
D5 -8			1N60PSA	DIØDE		*1,2
D5 .6		*	HSM88AS	CHIP DIØDE		*3
D9			DAP202K	DIØDE		*1,2
D9			1SS181	CHIP DIØDE		
D10 .11			1SS106	DIØDE		
D12 .13			DAN202(K)	CHIP DIØDE		*1,2
D12 .13			1SS184	CHIP DIØDE		
D14			1SS133	DIØDE		*1,2
D14			1SS184	CHIP DIØDE		*3
D15			DAN202(K)	CHIP DIØDE		*1,2
D15			1SS184	CHIP DIØDE		
D16			1SS133	DIØDE		

*1 : S/No. 705-707XXXX (W,T)

*2 : S/No. 705-707XXXX (K,M1,M2)

*3 : S/No. 708XXXX- (K,M1,M2,W,T)

PARTS LIST

* New Parts

Parts without Parts No. are not supplied.

Les articles non mentionnés dans le Parts No. ne sont pas fournis.

Telle ohne Parts No. werden nicht geliefert.

Ref. No. 参照番号	Address 位置	New Parts 新	Parts No. 部品番号	Description 部品名 / 規格	Desti- nation 仕向	Re- marks 備考
D17			1SS181	CHIP DIODE	*1,2	
D17			1SS184	CHIP DIODE	*3	
D17 ,18			DAP202K	CHIP DIODE		
D18			1SS181	CHIP DIODE	*1,2	
D19		*	1SS226	CHIP DIODE		
D20			1SS133	DIODE		
D21			1S2208	DIODE		
D22			DAN202(K)	CHIP DIODE	*1,2	
D22			1SS184	CHIP DIODE		
D23			DAP202K	CHIP DIODE	*1,2	
D23			1SS181	CHIP DIODE		
D24		*	1SS272	CHIP DIODE	*3	
D24 ,25			BA282	DIODE	*1,2	
D26			1SS184	CHIP DIODE	*3	
D26			1S1587	DIODE	*1,2	
D27			VD1223	VARISTOR	*1,2	
D27		*	1SS226	CHIP DIODE	*3	
D28			DAP202K	CHIP DIODE	*1,2	
D28			1SS181	CHIP DIODE		
D29			MTZ11JC	ZENER DIODE		
D30			MTZ6.2JA	ZENER DIODE		
D31			DAP202K	CHIP DIODE	*1,2	
D31			1SS181	CHIP DIODE		
D32		*	HSM88AS	CHIP DIODE	*3	
D32		*	1SS226	DIODE	*1,2	
D33 ,34			DAN202(K)	CHIP DIODE	*1,2	
D33 ,34			1SS184	DIODE		
D35			1SS181	CHIP DIODE		
IC1			TA7302P	IC(FM IF)	*3	
IC2			TA7761P	IC(FM IF)		
IC3			NJM4558D	IC(OP AMP X2)		
IC3			UPC4558C	IC(OP AMP X2)		
IC4			AN612	IC(BALANCED MODULATOR)		
IC5			UPC78M08H	IC(VOLTAGE REGULATOR/ +8V)		
Q1 -3			3SK73(GR)	FET		
Q4			2SK125	FET		
Q5			2SC2714(Y)	CHIP TRANSISTOR		
Q6			2SC2712(Y)	CHIP TRANSISTOR		
Q7		*	DTC114EK	DIGITAL TRANSISTOR		
Q8 ,9			2SC2712(Y)	CHIP TRANSISTOR		
Q10			DTA114EK	DIGITAL TRANSISTOR		
Q11		*	DTC114EK	DIGITAL TRANSISTOR		
Q12 ,13			2SC2712(Y)	CHIP TRANSISTOR		
Q14 ,15		*	2SK208(O)	CHIP FET		
Q16			2SA1162(Y)	TRANSISTOR		
Q17		*	DTC114EK	DIGITAL TRANSISTOR		
Q18 ,19			2SC2714(Y)	CHIP TRANSISTOR		
Q20			2SC2712(Y)	CHIP TRANSISTOR		
Q21		*	DTC114EK	DIGITAL TRANSISTOR		
Q22			DTA114EK	DIGITAL TRANSISTOR		
Q23		*	DTC114EK	DIGITAL TRANSISTOR		
Q24			3SK73(GR)	FET		
Q25 -27		*	2SC3324(G,B)	CHIP TRANSISTOR		
Q28 ,29		*	DTC114EK	DIGITAL TRANSISTOR		
Q30			2SA1115(E)	TRANSISTOR		

*1 : S/No. 705-707XXXX (W,T)

*2 : S/No. 705-707XXXX (K,M1,M2)

*3 : S/No. 708XXXX- (K,M1,M2,W,T)

PARTS LIST

× New Parts

Parts without Parts No. are not supplied.

Les articles non mentionnés dans le Parts No. ne sont pas fournis.

Teile ohne Parts No. werden nicht geliefert.

Ref. No. 参照番号	Address 位置	New Parts 新	Parts No. 部品番号	Description 部品名 / 規格	Desti- nation 仕 向	Re- marks 備考
Q31			2SC2712(Y)	CHIP TRANSISTOR		
Q32			2SA1307(Y)	TRANSISTOR		
Q33			2SA1162(Y)	CHIP TRANSISTOR		
Q34			2SC3419(Y)	TRANSISTOR		
Q35		*	DTC114EK	DIGITAL TRANSISTOR		
Q36			2SC2712(Y)	CHIP TRANSISTOR		
Q201			3SK129(Q,R)	FET		
Q202			3SK74(L)	FET		
TH1		*	112-202-2	THERMISTOR (2K)		
TH2			112-102-2	THERMISTOR (1K)		
TH3			112-103-2	THERMISTOR (10K)		
-		*	X59-1090-00	MIC AMP UNIT	TW *1	
-		*	X59-1100-00	-6V DC-DC CONV. UNIT		
-		*	X59-1110-00	AF PRE AMP UNIT		
-		*	X59-1120-00	SOL SW UNIT		
-		*	X59-3000-00	MIC AMP UNIT	KM1M2 *2	
-		*	X59-3000-01	MIC AMP UNIT	KM1M2 *3	
-		*	X59-3000-01	MIC AMP UNIT	TW *3	

*1 : S/No. 705-707XXXX (W,T)

*2 : S/No. 705-707XXXX (K,M1,M2)

*3 : S/No. 708XXXX- (K,M1,M2,W,T)

TR-751A/E

EXPLODED VIEW

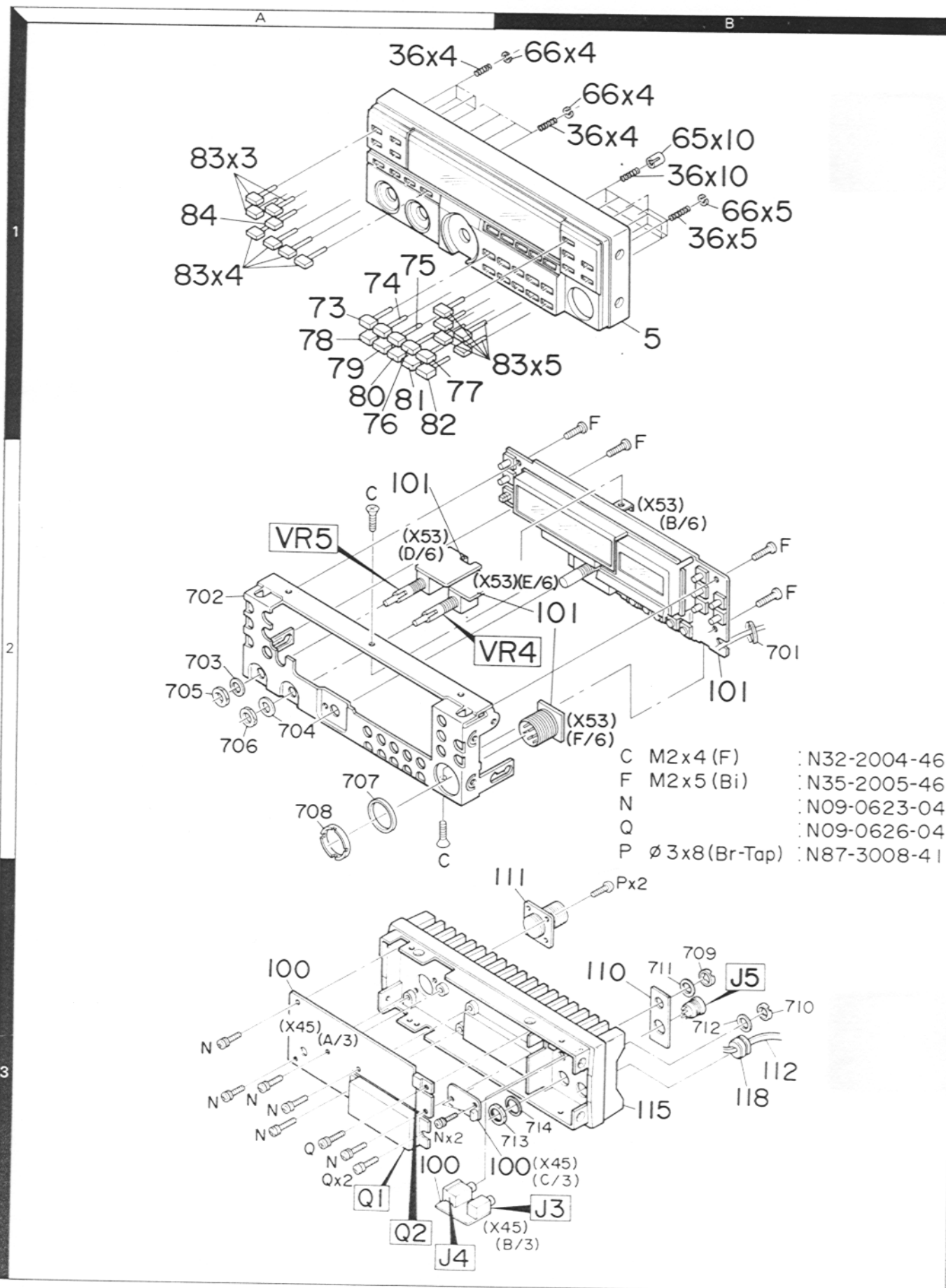

C	M2x4 (F)	: N32-2004-46
F	M2x5 (Bi)	: N35-2005-46
N		: N09-0623-04
Q		: N09-0626-04
P	∅3x8 (Br-Tap)	: N87-3008-41

Parts with the exploded numbers larger than 700 are not supplied.

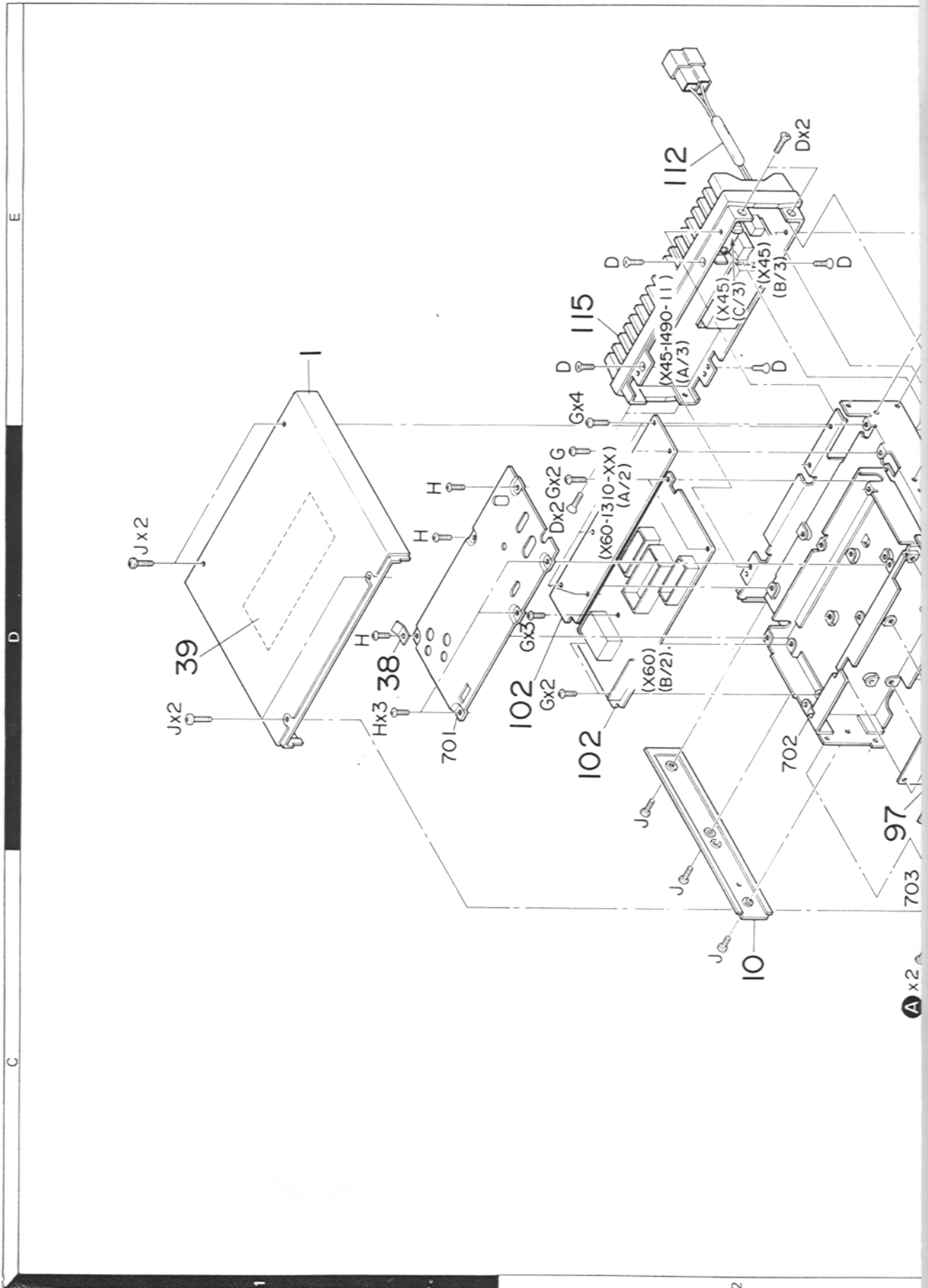

TR-751A/E

EXPLODED VIEW

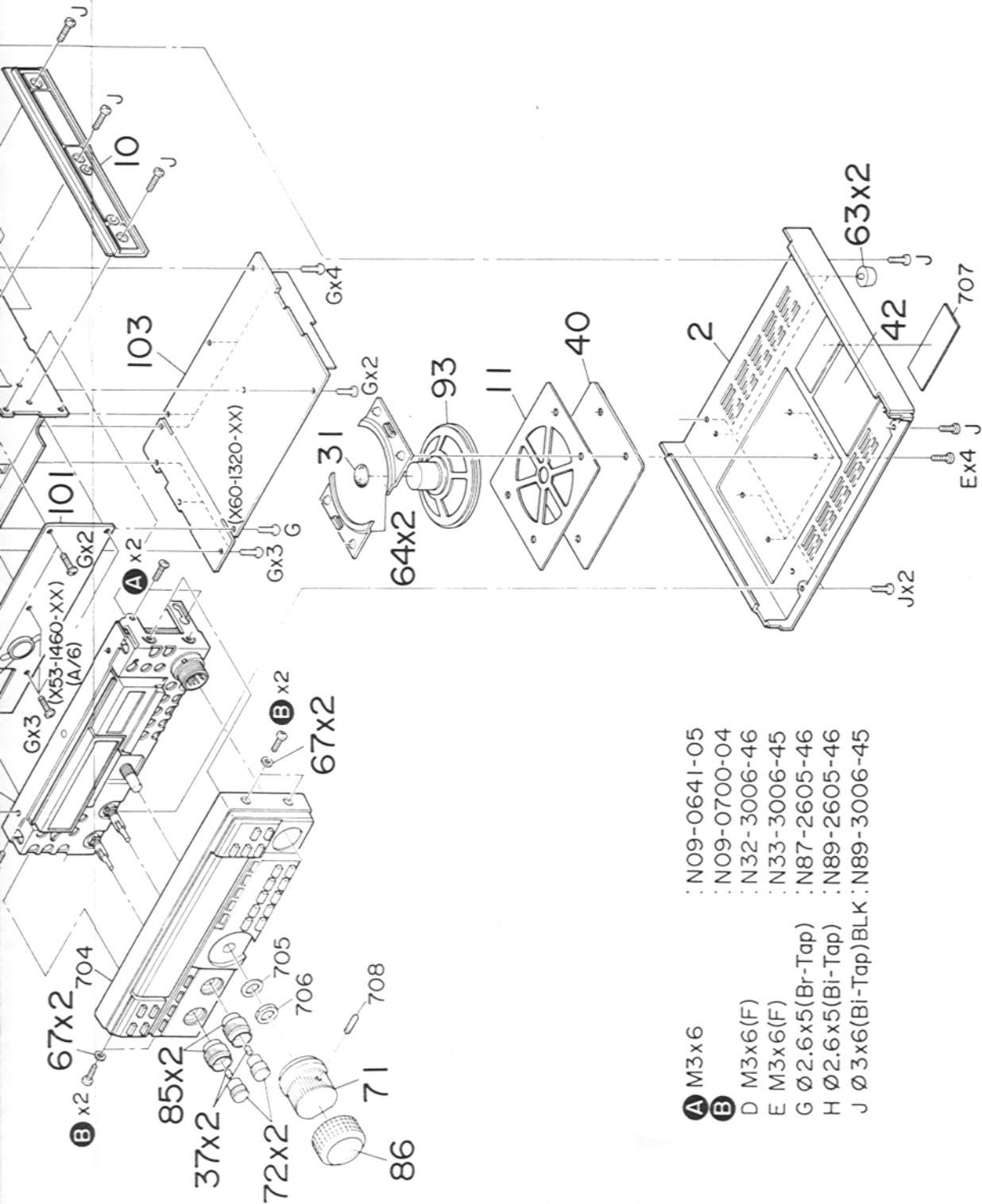

- A** M3x6 : N09-0641-05
- B** M3x6(F) : N09-0700-04
- D M3x6(F) : N32-3006-46
- E M3x6(F) : N33-3006-45
- G Ø2.6x5(Br-Tap) : N87-2605-46
- H Ø2.6x5(Bi-Tap) : N89-2605-46
- J Ø3x6(Bi-Tap)BLK : N89-3006-45

Parts with the exploded numbers larger than 700 are not supplied.

LEVEL DIAGRAM

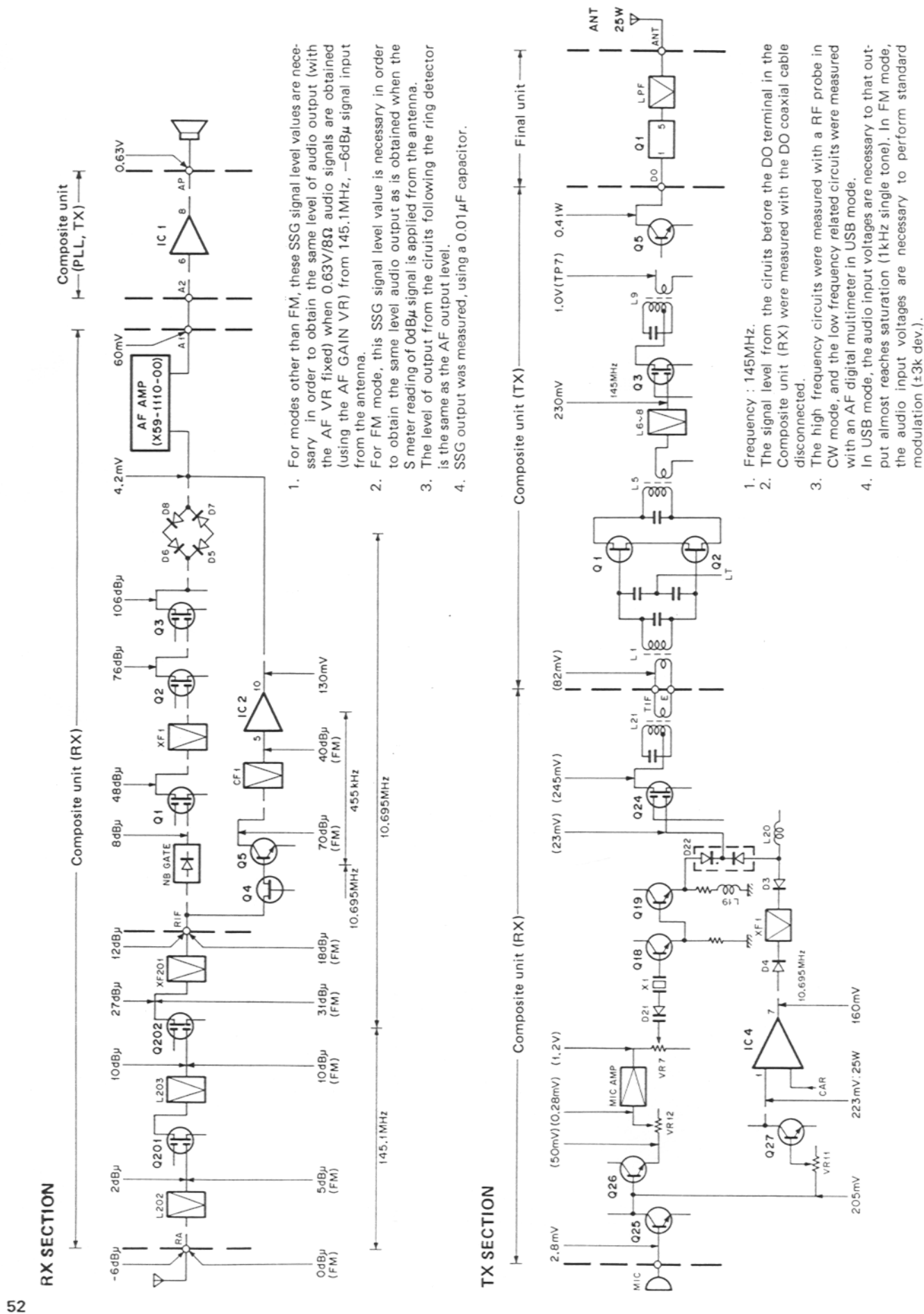

ADJUSTMENT

REQUIRED TEST EQUIPMENT

1. **DC V.M**
 - 1) High input impedance
2. **RF VTVM (RF V.M)**
 - 1) Input impedance : 1M Ω min., 2pF max.
 - 2) Voltage range : F.S = 10mV ~ 300V
 - 3) Frequency range : Up to 450MHz
3. **Frequency Counter (f. counter)**
 - 1) Input sensitivity : Approx. 50mV
 - 2) Frequency range : Up to 450MHz
4. **DC Power Supply**
 - 1) Voltage : 10V ~ 17V, variable
 - 2) Current : 8A min.
5. **Power Meter**
 - 1) Measurement range Approx. : 30W, 3W, 1W
 - 2) Input impedance : 50 Ω
 - 3) Frequency range : 450MHz
6. **AF VTVM (AF V.M)**
 - 1) Input impedance : 1M Ω min.
 - 2) Voltage range : F.S = 1mV ~ 30V
 - 3) Frequency range : 50Hz ~ 10kHz
7. **AF Generator (AG)**
 - 1) Output frequency : 100Hz ~ 10kHz
 - 2) Output voltage : 0.5mV ~ 1V
8. **Linear Detector**
 - 1) Frequency range : 450MHz
9. **Field Strength Meter**
 - 1) Frequency range : 450MHz
10. **Directional Coupler**
11. **Oscilloscope**
 - 1) High sensitivity oscilloscope with horizontal input terminal
12. **SSG**
 - 1) Frequency range : 144MHz and 430MHz bands
 - 2) Modulation : AM and FM MOD.
 - 3) Output level : -20dB to 100dB
13. **Dummy Load**
 - 1) 8 Ω , 5W (approx.)
14. **Noise Generator**
 - 1) Must generate ignition-like noise containing harmonics beyond 450MHz.

15. Sweep Generator

- 1) Sweep range : 1440MHz and 430MHz bands

16. Tracking generator

PREPARATION

- 1) Unless otherwise specified, knobs and switches should be set as follows **Table 10**.

POWER SW	ON	COM (K, M)	OFF
VOL VR	MIN	TONE (W, T)	OFF
SQL VR	MIN	LOW SW	OFF
RIT VR	CENTER	NB SW	OFF
RF GAIN VR	MAX	RIT SW	OFF
		DCL SW	OFF

Table 10

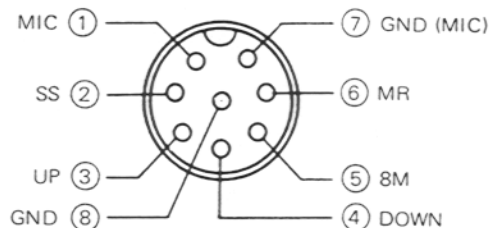

Fig. 12 MIC terminals (view from front panel side)

- 2) Use an insulated adjusting rod to adjust trimmers and coils.
- 3) To prevent damaging SSG, never set the stand by switch to SEND while adjusting the receiver section.
- 4) Be sure to turn the power switch OFF, before connecting the power cable to a power source.
- 5) SSG output levels are those at the time the output terminal is open.
- 6) Meter and display section should be set as follows **Fig. 13**.

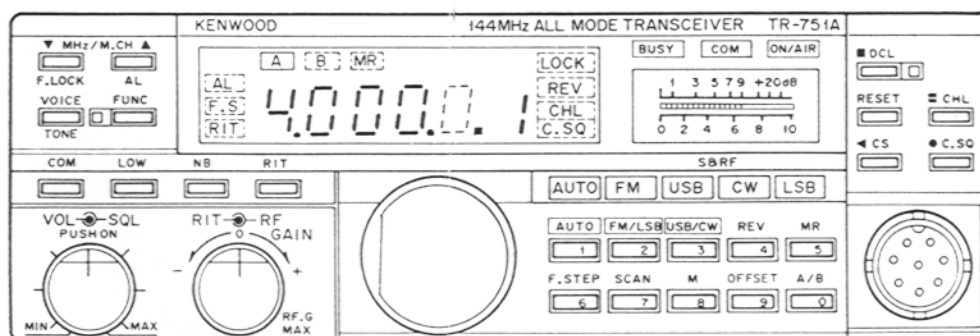

Fig. 13

ADJUSTMENT

TX-RX ADJUSTMENT (COMMON)

Item	Condition	Measurement			Adjustment			Specification/Remarks
		Test equipment	Unit	Terminal	Unit	Part	Method	
1. Setting	1) Disconnect connectors J12 (TIF) and J202 (LR) from the Composite unit (RX). 2) Connect DC power supply to the DC connector on the panel (13.8V DC). Before connecting the DC power supply, turn the Power switch off.							
2. Reset	1) Turn the Power switch ON, holding the M switch down. 2) Release the M switch and select the FM mode. MODE : FM							Δ 4.000 Beeper sound. Δ AUTO FM LED on.
3. Voltage setting	1) RF GAIN VR : MAX	Digital multimeter	RX	TP3 (3J)	RX	VR1 (3J)	4.0V	$\pm 0.1V$
	2) Transmit signals (9T).			TP1 (4I)		VR13 (3H)	9.1V	$\pm 0.1V$
	3) Return to receive mode.							

PLL SYSTEM ADJUSTMENT

Item	Condition	Measurement			Adjustment			Specification/Remarks
		Test equipment	Unit	Terminal	Unit	Part	Method	
1. PLL (B)	1) Remove the six screws from the shield plate of the Composite unit (PLL). FREQ. : Any value ($\square.00$) MODE : FM	Digital multimeter	PLL	TP9 (4D)	PLL	L34 (4D)	6.0V	$\pm 0.1V$
	2) MODE : LSB F.STEP : ON FREQ. : Any value ($\square.001.4$) or ($\square.001.4$).							
	3) MODE : LSB FREQ. : Any value ($\square.001.5$)	RF V.M		TP4 (3D)	PLL	L21 (3D)	Turn the core counter-clockwise from the MAX position to lower the voltage by 0.02V.	0.3–0.8V Turn the core counter-clockwise from the MAX position to lower the voltage by 0.8V in case of over 0.8V.
2. 10.24MHz	1) MODE : LSB FREQ. : Any value	RF V.M	PLL	TP5 (3E)	PLL	L24 (3E)	MAX	0.3–0.5V
3. RIT BPF	1) MODE : LSB FREQ. : Any value	RF V.M	PLL	TP3 (3C)	PLL	L28 (3D) L29 (3D)	Repeat for MAX. If the voltage does not reach 0.25V, adjust as follows: Turn the core of L29 up to case surface level. Repeat the adjustment of L28 and L29 until you reach the MAX deflection.	0.25–0.50V
4. PLL (A)	1) MODE : LSB FREQ. : Any value	RF V.M	PLL	TP6 (4C)	PLL	L20 (3C) L19 (3C) L18 (3C)	Repeat for MAX.	1.5–2.0V
	2) FREQ. : 4.000.0 F.STEP : ON	Digital multimeter		TP2 (4B)	Sub-VCO	TC1 (3C)	1.7V T,W \leftarrow 3.0V K,M	$\pm 0.05V$
	3) FREQ. : 4.999.9 T,W \leftarrow 8.000.0 K,M							2.6V $\pm 0.2V$ T,W \leftarrow 5.5V $\pm 0.2V$ K,M

ADJUSTMENT

Item	Condition	Measurement			Adjustment			Specification/Remarks
		Test equipment	Unit	Terminal	Unit	Part	Method	
4. PLL (A)	4) Connect J202 (LR) to the Composite unit (RX). FREQ. : 4.999.9 T,W 6.000.0 K,M	RF V.M	PLL	TP1 (3B)	PLL	TC3 (3B)	MAX	
	5) MODE : FM FREQ. : 5.00 T,W 6.00 K,M	f.counter				TC4 (3D)	134.305.000MHz T,W 135.305.000MHz K,M	±50Hz
	6) MODE : USB RIT VR : Center RIT SW : ON					VR8 (4E)	Use the same freq' as when the RIT is off.	±50Hz (134.306.50MHz).
	7) RIT VR : MIN (- direction)							Freq' should be at least -1.2kHz lower than that obtained in step 6).
	8) RIT VR : MAX (+ direction)							Freq' should be at least 1.2kHz higher than that obtained in step 6).
5. Carrier	1) MODE : USB	RF V.M	PLL	J12-CAR (4E)	PLL	L40 (4E)	Turn the core counter-clockwise from the peak point to set the value of 0.3V.	
	2) MODE : USB LSB					TC7 (3E) TC5 (3E)	10.693.50MHz 10.696.50MHz	±50Hz
	3) MODE : CW Select CW and transmit.					TC6 (3E)	10.694.30MHz	±50Hz
	4) Return to receive.							

RECEIVER SYSTEM ADJUSTMENT

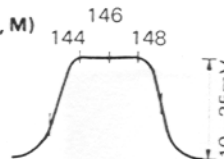
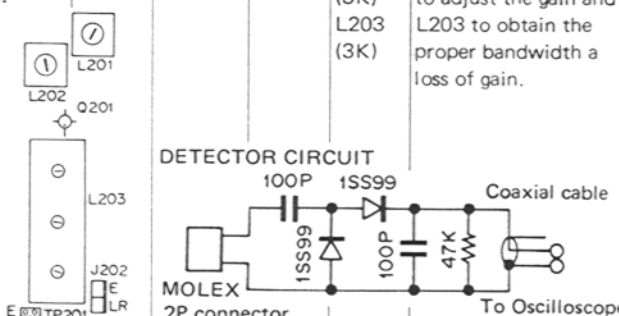
Item	Condition	Measurement			Adjustment			Specification/Remarks
		Test equipment	Unit	Terminal	Unit	Part	Method	
1. Helical	1) Disconnect J202 (LR) from the Composite unit (RX) and set the RF GAIN VR to MAX. Connect the sweep gen. to the ANT terminal (35dB) and the oscilloscope to the detector output. After adjustment, reconnect J202.	Detector SCOPE Sweep Gen.	RX	TP201 (4K)	RX	L201 (2K) L202 (3K) L203 (3K)	Adjust for the waveform shown right, using L201 and L202 to adjust the gain and L203 to obtain the proper bandwidth a loss of gain.	<p>147MHz marker appears slightly above 143MHz marker.</p>  <p>(W, T)</p>  <p>(K, M)</p>
 <p>DETECTOR CIRCUIT</p> <p>MOLEX 2P connector</p> <p>To Oscilloscope</p>								
2-1. Sensitivity adjustment (FM)	1) Connect SSG to ANT pin. SSG MOD : 1kHz SSG DEV : 3kHz Connect the 8Ω dummy resistor, oscilloscope, and AF digital multimeter to the EXT SP terminal.							NOTE : Do not connect a microphone to the MIC jack.
	2) SQL VR : MIN RF GAIN VR : MAX							

ADJUSTMENT

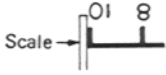
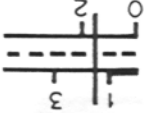
Item	Condition	Measurement			Adjustment			Specification/Remarks
		Test equipment	Unit	Terminal	Unit	Part	Method	
2-1. Sensitivity adjustment (FM)	3) MODE : FM FREQ. : 4.94 T,W 5.94 K,M SSG output : 0dB (unmodulated)	S meter			RX	L204 (4K) L206 (4K) L207 (4K) L7 (4J) L13 (4J)	Repeat for MAX.	12dB SINAD -8dBμ or less
	4) SSG output : -10dB (modulated)	AF V.M			RX	PLL TC3 (3B) L15 (4I)	MAX MAX	
2-2. Sensitivity adjustment (SSB)	1) MODE : CW RF VAIN VR : MIN	SCOPE	RX	TP4 (3J)	RX	TC1 (2I)	MIN	5mVp-p or less
	2) SSG output : -10dB (unmodulated) RF GAIN VR : MAX	AF V.M				L3 (3K) L4 (3J) L5 (3I) L6 (3I) L2 (4K) L1 (4K)	Repeat for MAX.	MODE : CW (or USB or LSB) 10dB or more at -12dBμ
3-1. S meter (FM)	1) MODE : FM RF GAIN VR : MAX SSG output : 0dB (unmodulated)	S meter			RX	L207 (4K) L7 (4J)	MAX	
	2) SSG output : 0dB (modulated)					VR5 (3J)	Set the RF scale to a 2.	
	3) SSG output : 30dB (modulated)					VR6 (2J)	Set the RF scale to a value greater than 10 times that the present scale.	
	4) Repeat steps 2) and 3).							
3-2. S meter (SSB)	1) MODE : CW SSG output : OFF (no signal)	S meter			RX	VR3 (2J)	Set the S meter to mechanical 0.	
	2) RIT SW : ON SSG output : 0dB (unmodulated) Apply a signal and set the S meter to MAX with the RIT VR.					L5 (3I)	Turn the core counter-clockwise to set the S meter to 1.5.	Center point between S scale's 1 and RF scale's 2 (upside down view). 
	3) SSG output : 30dB	S meter			RX	VR4 (2J)	Set S meter to +10.	
	4) Repeat steps 2) and 3).							

ADJUSTMENT

Item	Condition	Measurement			Adjustment			Specification/Remarks
		Test equipment	Unit	Terminal	Unit	Part	Method	
4. Noise blanker	1) MODE : CW SSG output : 10dB	DC V.M	RX	TP2 (4J)	RX	L10 (3J) L8 (4J)	MIN	Turn the NB switch on and then off and check that the noise blanker operates.
	2) Connect the noise generator to the ANT terminal.							
5. SSB squelch	1) Connect the SSG to the ANT terminal. SSG output : -5dB RIT SW : ON Turn the RIT VR until the AF V.M reads MAX.							
	2) SQL VR : MAX	AF V.M SCOPE			RX	VR2 (2J)	Turn the VR counter-clockwise to the point at which squelch just close, then turn the VR clockwise to the point at which squelch just opens.	
6. Open channel search	1) Connect the Control unit's two TP1 pins to ground. MODE : FM SSG output : -10dB (unmodulated)	BUSY LED			CONT	VR1 (4E)	Turn the VR to the point at which the BUSY LED goes on and off.	

TRANSMITTER SYSTEM ADJUSTMENT

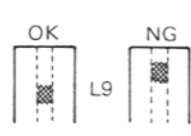
Item	Condition	Measurement			Adjustment			Specification/Remarks
		Test equipment	Unit	Terminal	Unit	Part	Method	
1. IF output	1) Disconnect J12 (TIF) from the Composite unit (RX). MODE : FM Composite unit (RX) TC2 : Center Transmit.	RF V.M	RX	J12-TIF (3K)	RX	L21 (3K)	MAX	0.23-0.35V Back panel  Front panel
2. Carrier level	1) MODE : CW Transmit.	RF V.M	RX	J12-TIF (3K)	RX	VR10 (3I)	0.25V	±0.01V
3. FM freq'	1) MODE : FM Transmit	f.counter	RX	J12-TIF (3K)	RX	TC2 (4I)	10.695.0MHz	±50Hz
	2) Return to receive mode and reconnect J12.							
4. Drive output	1) MODE : CW FREQ. : 5.06 T,W 6.06 K,M Connect 0.6 to 1.0W power meter to the DO terminal of the Composite unit (TX).					L5(2B) L6(2B) L7(2C) L8(2C) L9(2C) L1(3B)	Turn TC1 counter-clockwise to set drive output to 0.3W and repeat until MAX.	0.3W or more
						TC1 (2D) TC2 (2D) L7(2C) L8(2C) L9(2C)	Repeat for MAX. 	

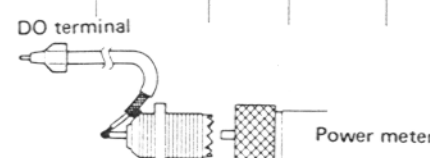

DO terminal

Power meter

ADJUSTMENT

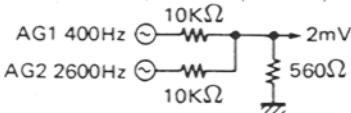

Item	Condition	Measurement			Adjustment			Specification/Remarks
		Test equipment	Unit	Terminal	Unit	Part	Method	
5. Transmit	1) Connect the coaxial cable to the DO terminal of the Composite unit (TX). Connect the power meter to the ANT terminal. Power meter : 50W Composite unit (TX) VR4 : MAX Final unit VR3 : MAX MODE : CW 144.00–145.999MHz T,W 144.00–147.399MHz K,M Transmit.	Power meter						35W or more
					TX	VR4 (2E)	27W	Current consumption : 3.2A or less Hi power : 10 to 14W Low power : 0.5 to 1.3W
6. RF meter	1) MODE : CW Transmit.	RF meter			Final	VR1 (2B)	Set so the RF scale reads 8.	
7. Protection	1) MODE : CW Transmit.	DC V.M	Final	TP1 (2K)	Final	VR2 (2K)	MIN	
	2) Disconnect the power meter from the ANT terminal and short the ANT terminal.	DC A.M (DC power supply galvanometer)				VR3 (2B)	3.5A	
8. Low power	1) LOW SW : ON Connect the power meter to the ANT terminal.	Power meter			TX	VR3 (2E)	5W	
		RF meter						RF scale should read 2 to 5.
9. DEV	1) MODE : FM LOW SW : OFF (HI) Apply a 1kHz, 28mV signal T,W or 50mV signal K,M to MIC terminal. Linear detector • MS-51A/61A (Anritsu) HPF : OFF LPF : 20kHz De-emphasis : OFF	Linear detector			RX	VR7 (4I)	4.6kHz	±100Hz
						VR12 (3I)	3.0kHz	±100Hz
								Ensure that the freq' is 4.6kHz±100Hz. If it is not, return to step 1).
10. TONE T,W	1) MIC input : OFF TONE SW : ON TP9 terminal shorted. (CONT unit)	f.counter	CONT	TP9 (4K)	CONT	VR2 (4K)	Connect f. counter to linear detector output.	
11. Carrier point	1) MODE : USB Composite unit (RX) VR11 : Center Disconnect J12 (TIF) from Composite unit (RX). Apply 400Hz and 2600Hz signals to the MIC terminal at the same time simultaneously. (using a two tone generator). Set the AG outputs so that the output voltage is 2mV.	SCOPE	RX	J12-TIF (3K)	PLL	TC7 (3E)		Signal should not contain any noise.
								





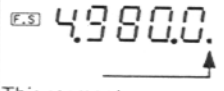
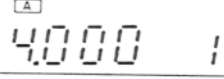
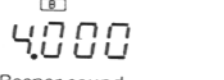
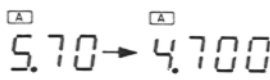

ADJUSTMENT

Item	Condition	Measurement			Adjustment			Specification/Remarks
		Test equipment	Unit	Terminal	Unit	Part	Method	
11. Carrier point	2) If only one AG is available, set the AG output to 10W AG : 1.5kHz	SCOPE	RX	J12-TIF (3K)	PLL	TC7 (3E)	Change AF freq' from 400Hz to 2600Hz, and adjust so that the same power is obtained at both frequencies. (in USB and LSB modes.)	
	TC5 (3E)					Make the same adjustment as in step 1).		
	4) Connect J12 to the Composite unit (RX).							
12. Carrier suppression	1) MODE : LSB LOW SW : ON Composite unit (RX) VR11 : MIN	Spectrum analyzer			RX	VR8 (3I) VR9 (3I)	Repeat for until MIN.	-55dB or less NOTE : If you perform the carrier point adjustment, you must also adjust the carrier suppression.
	2) MODE USB							-45dB or less
13. Spurious adjustment (10.695 MHz)	1) MODE : LSB LOW SW : ON	Spectrum analyzer			TX	VR1 (2B)	Adjust so that spurs at ± 10.695 MHz, are minimized (fine adjustment).	-60dB or less
14. SSB MIC gain	1) LOW SW : OFF (HI) MODE : USB MIC input : 2.8mV/1500Hz T,W MIC input : 5.0mV/1500Hz K,M	Power meter			RX	VR11 (4H)	13W	
15. Side tone	1) MODE : CW AF VR : Center Connect a CW key or (its equivalent) to the KEY terminal. Connect a 8 Ω dummy load, AF digital multimeter, and oscilloscope to the EXT. SP terminal.	AF V.M			TX	VR6 (3D)	Press the key, and confirm that signals are transmitted, and set 0.5V	± 0.1 V
16. Break-in	1) MODE : CW Composite unit (TX) VR7 : Center	ON AIR LED						Check that the ON AIR LED remains on for a brief period after the key is released.
17. BEEP	1) SQL VR : Select the squelch threshold point. MODE : Any mode AF VR : Center							
	2) M SW : ON Receive signals	SCOPE (connect to audio output)			TX	VR5 (3D)	0.6Vp-p	± 0.1 V
18. RX Tight squelch (FM)	1) MODE : FM SQL VR : Fully CW (MAX) SSG MOD : 1kHz SSG DEV : 3kHz SSG Output : -4dB	AF V.M SCOPE			RX	VR14 (4I)	Adjust the VR14 slowly and stop at the threshold point.	

ADJUSTMENT

Microprocessor operation check

Item	Condition	Operation check																									
1. Reset	1) Turn the POWER switch on, holding down the M switch.	<div style="text-align: center;">  </div> <p style="text-align: center;">Beeper sound.</p>																									
2. MODE function (AUTO, FM, USB, CW, LSB)	1) Press a mode switch (press FM).	Morse code F " - - - - - " is output.																									
	2) Press FM again.	System enters LSB mode and Morse code L " - - - - - " is output.																									
	3) Press USB.	System enters USB mode and Morse code U " - - - - - " is output.																									
	4) Press USB again.	System enters CW mode and Morse code C " - - - - - " is output.																									
3. Encoder /step	1) <table border="1" style="margin: 5px;"> <tr> <td>MODE</td> <td colspan="2">FM</td> <td colspan="2">SSB/CW</td> </tr> <tr> <td>STEP</td> <td>OFF</td> <td>ON</td> <td>OFF</td> <td>ON</td> </tr> <tr> <td>DEST.</td> <td></td> <td></td> <td></td> <td></td> </tr> <tr> <td>K.M</td> <td>5K</td> <td>10K</td> <td>5K</td> <td>50Hz</td> </tr> <tr> <td>T.W</td> <td>12.5K</td> <td>5K</td> <td>5K</td> <td>50Hz</td> </tr> </table>	MODE	FM		SSB/CW		STEP	OFF	ON	OFF	ON	DEST.					K.M	5K	10K	5K	50Hz	T.W	12.5K	5K	5K	50Hz	50Hz step operation (STEP ON, CW, SSB MODE ON) <div style="text-align: center;">  </div> <p style="text-align: center;">This segment goes on and off each time the encoder is clicked.</p>
MODE	FM		SSB/CW																								
STEP	OFF	ON	OFF	ON																							
DEST.																											
K.M	5K	10K	5K	50Hz																							
T.W	12.5K	5K	5K	50Hz																							
4. A/B	1) Reset the micro-processor (as in step 1.).	<div style="text-align: center;">  </div>																									
	2) Press A/B key.	<div style="text-align: center;">  </div> <p style="text-align: center;">Beeper sound.</p>																									
5. ▼MHz/ M.CH▲	1) MHz step operation. Press ▼ or ▲ key.	A value on the MHz digit increment by one. Example <div style="text-align: center;">  </div> <p style="text-align: center;">Note : In auto mode, mode changes from 0 FM → USB.</p>																									
	2) M CH operation Enter a frequency into memory. Press MR key. PRESS ▼ or ▲ key.	<div style="text-align: center;">  </div> <p style="text-align: center;">The frequency is displayed.</p> <div style="text-align: center;">  </div> <p style="text-align: center;">The number in this position changes.</p>																									

Item	Condition	Operation check
6. FUNC. function	1) F.LOCK operation Press FUNC key (orange).	Beeper sound. <div style="text-align: center;">  </div> LOCK at upper right of LCD goes on. Encoder or keyboard is not possible.
	Press MHC key. Repeat the above operation.	Beeper sound. <div style="text-align: center;">  </div> LOCK goes off.
	2) AL (alert) operation. Press FUNC key. Press /M.CH key.	Beeper sound. <div style="text-align: center;">  </div> AL at upper left of LCD goes on.
	Repeat above operation.	Beeper sound. <div style="text-align: center;">  </div> AL goes off.
7. RIT	1) Doesn't operate in the FM mode.	Warning output when RIT is turned on in FM mode.
	2) Select CW or SSB mode, and press RIT key.	Beeper sound. RIT at lower left of LCD goes on.
	3) Press RIT key again.	RIT goes off.
8. COM CH.	1) Press COM key.	← A and B disappear. <div style="text-align: center;">  </div> COM above meter goes on. Frequency does not change even if encoder is turned.
9. Memory entry	1) Set the frequency to be entered into memory and press the M key.	During the period the beeper is sounding, press a key to enter the frequency.
9 and 0 indicate stop channels, so different frequency values can be set for reception and transmission.		
10. Memory recall (read the freq' that was set in in step 9.).	1) Press MR key.	Beeper sound. <div style="text-align: center;">  </div>
	2) Press MHz/M.CH key.	Frequency set in step 9. is displayed. Note : Mode also changes.

TOP VIEW

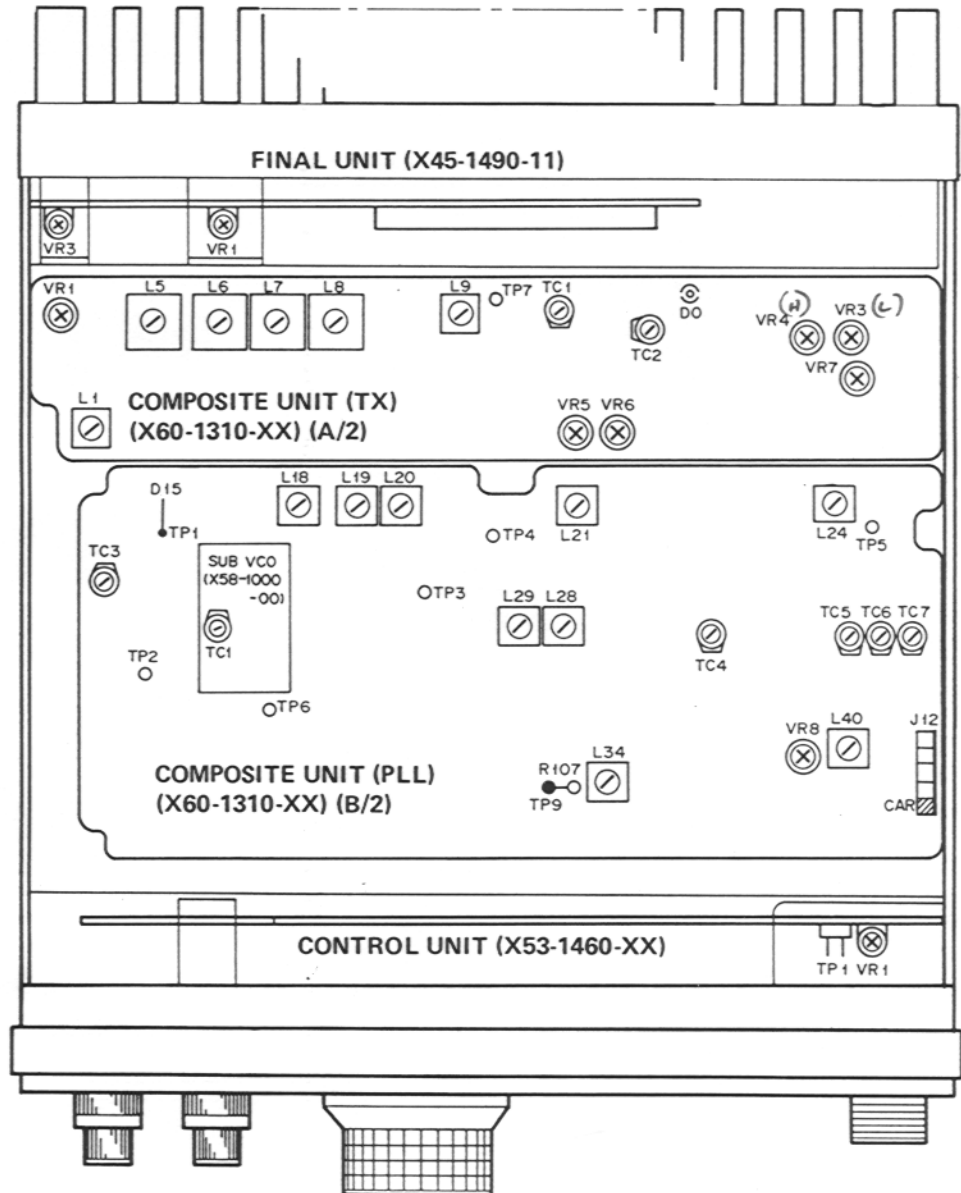
**COMPOSITE UNIT (PLL, TX) (X60-1310-XX)**

VR1 : 10.695MHz SPURIS
 VR3 : LOW POWER
 VR4 : HI POWER
 VR5 : BEEP LEVEL
 VR6 : SIDE TONE LEVEL
 VR7 : CW BREAK IN DELAY (CENTER)
 VR8 : RIT

L5-L9, L1 (TC1,2) : DRIVE LEVEL
 L20,19,18 : BPF COIL (115.925-115.945MHz)
 L21 : PLL (B) COIL (9.68-9.70MHz)
 L24 : 10.24MHz LEVEL
 L28,29 : RIT BPF COIL (106.245MHz)
 L34 : PLL (B) VCO (28-27MHz)
 L40 : CARRIER LEVEL (10,693.50MHz USB)

FINAL UNIT (X45-1490-11)

VR1 : RF METER LEVEL
 VR3 : PROTECTION (SHORT)

CONTROL UNIT (X53-1460-XX)

VR1 : OPEN CHANNEL SEARCH LEVEL

ADJUSTMENT TR-751A/E

BOTTOM VIEW

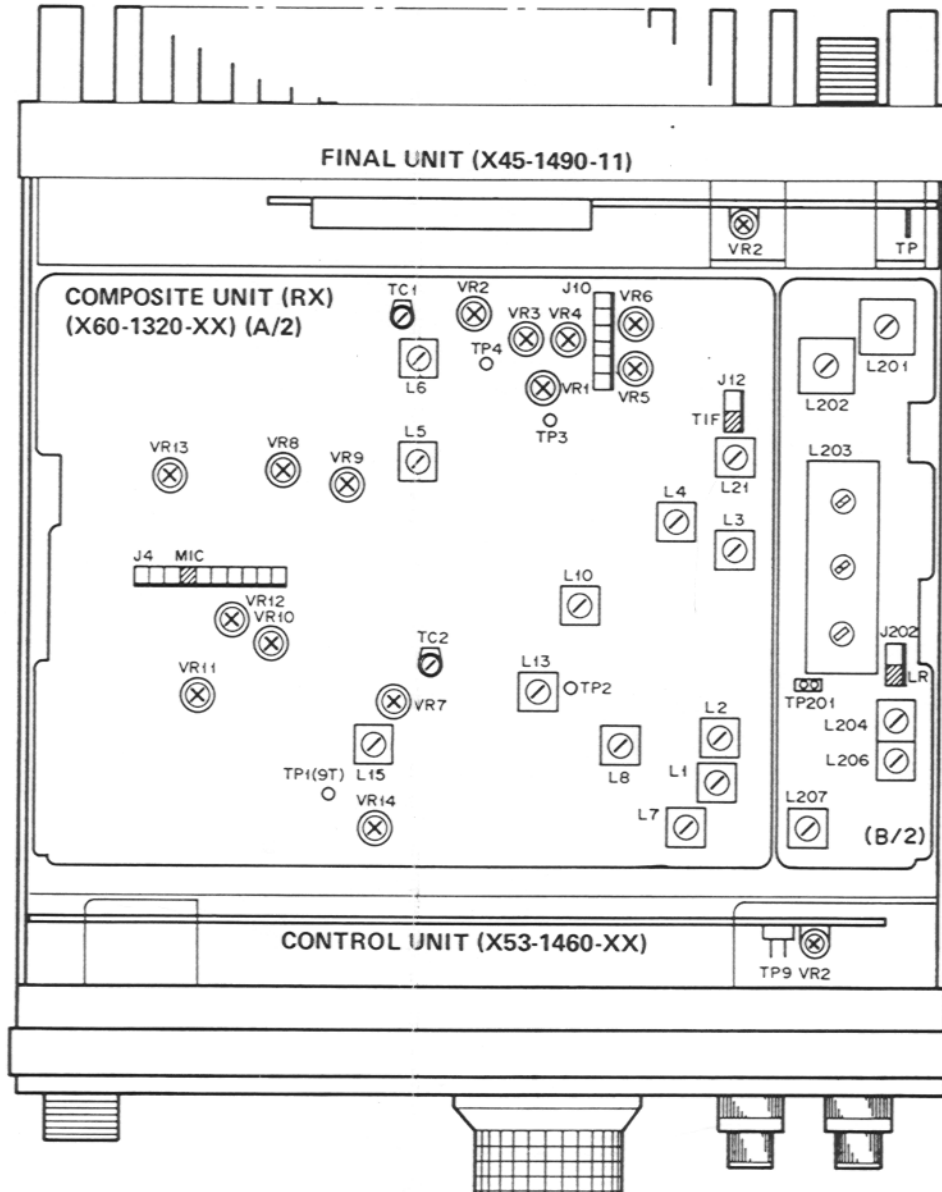

COMPOSITE UNIT (RX) (X60-1320-XX)

- VR1 : RF GAIN (4.0V)
- VR2 : SSB SQUELCH
- VR3 : S-φ SSB
- VR4 : S-9 SSB
- VR5 : S-2 FM
- VR6 : S-10 FM
- VR7 : DEV. MIC INPUT 28mV LINEAR DETECTOR 4.6kHz
- VR8,9 : CARRIER SUPPRESSION
- VR10 : CARRIER LEVEL 0.25V rms
- VR11 : SSB MIC GAIN MIC INPUT 2.8mV/1500Hz 6W
- VR12 : FM MIC GAIN MIC INPUT 2.8mV LINEAR DETECTOR 3.0kHz
- VR13 : TRANSMISSION 9V (9T)
- VR14 : TIGHT SQUELCH

- L201-203 : HELICAL
- L204,206,207,7,13,15 : FM SENSITIVITY
- L3-6,2,1 : SSB SENSITIVITY
- L10,8 : NOISE BLANKER

FINAL UNIT (X45-1490-11)

- VR2 : PROTECTION (NULL)
- CONTROL UNIT(X53-1460-XX)**
- VR2 : 1750Hz FREQUENCY ADJ.

BLOCK DIAGRAM

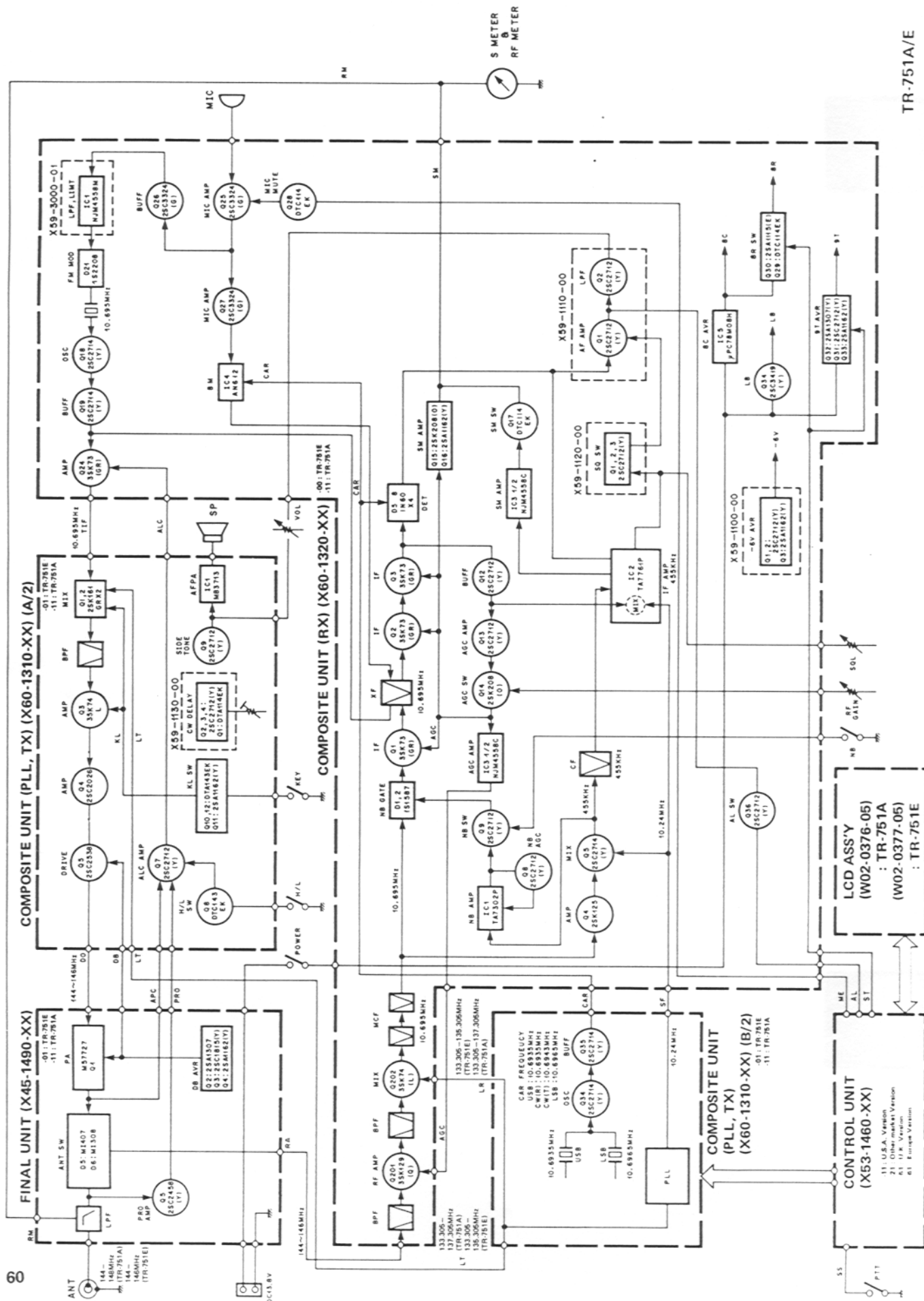

PC BOARD VIEWS

CONTROL UNIT (X53-1460-XX) -11 : K,M1 -21 : M2 -51 : T -61 : W
 Component side view

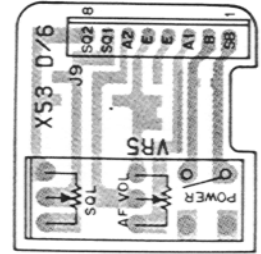
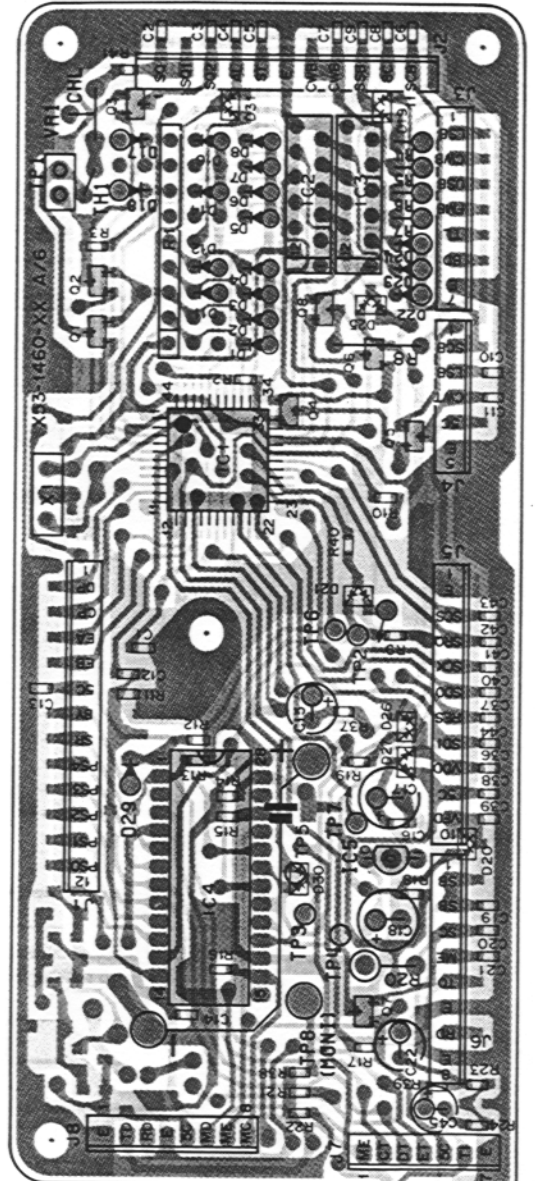
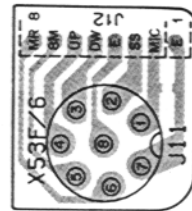
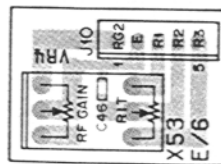
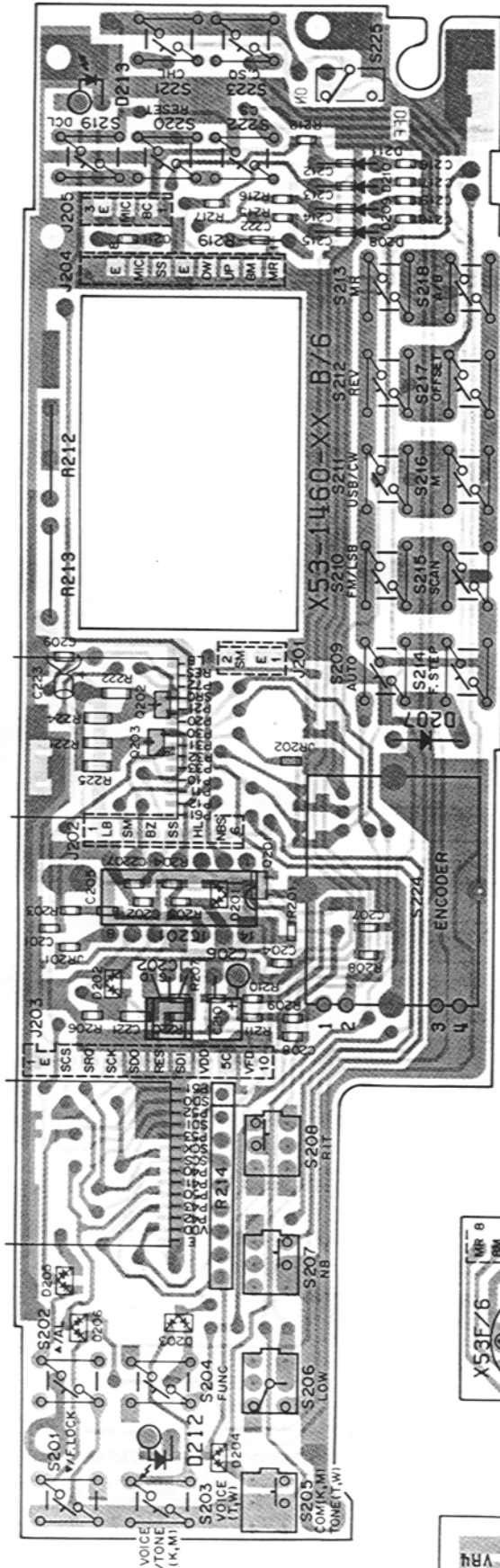

O1,2,4,6,201-203 : DTC114EK O3 : 2SC2712(Y) O5 : DTA114TK O7,8 : DTA114EK
 IC1 : μ PD7508HG-545-22 IC2 : DT5C124E IC3 : DT5A143E IC4 : μ PD7507SCT-215 IC5 : M5278L56 IC6 : NE555P IC201 : BU4584B IC202 : PST523C
 D1-8,11,12,14,16-18,22-24,207-211 : 1SS133 D19,20,25,26,30,31 : 1SS184 or DAN202K D21,27,201-206 : 1SS181 or DAP202K D29 : 1SS106 D212 : LN322GP D213 : LN422YP

A

B

C

D

E

F

CONTROL UNIT (X53-1460-XX) -11 : K,M1 -21 : M2 -51 : T -61 : W
 Foil side view

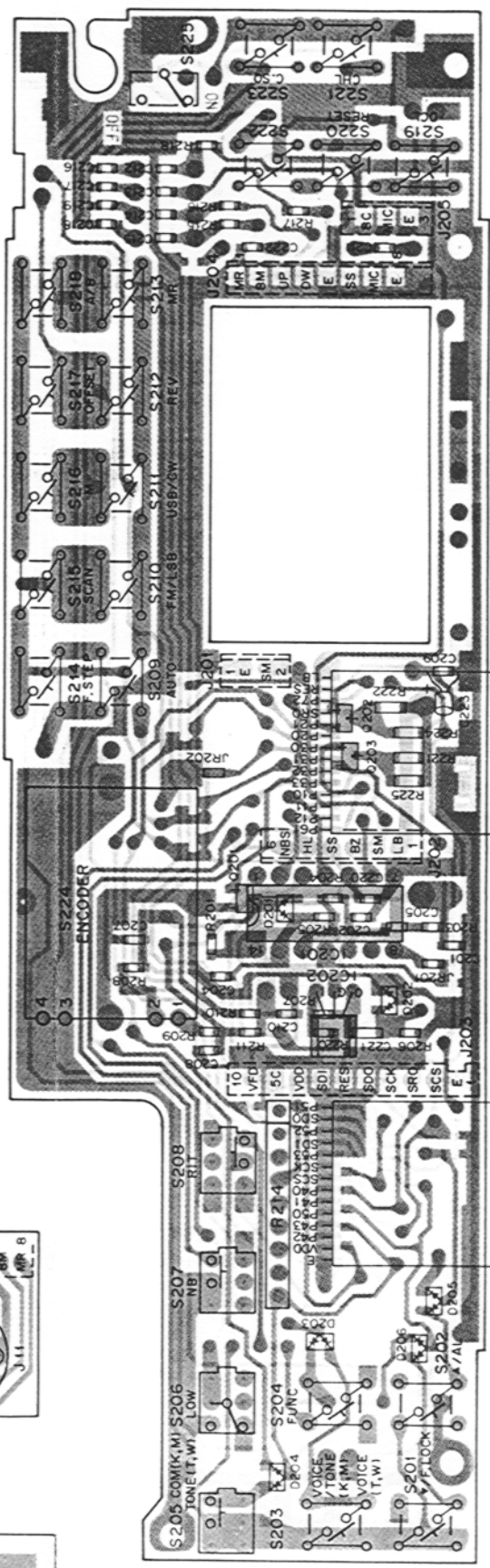
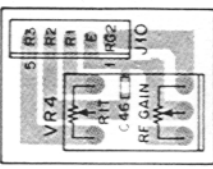
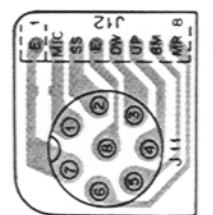
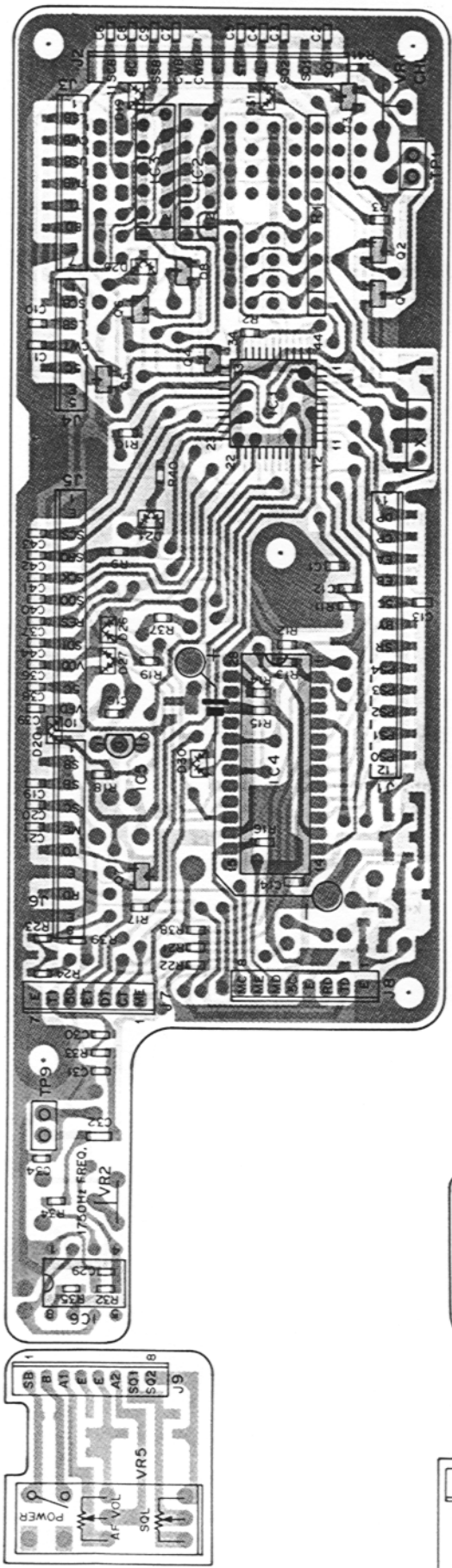

R22 : S/No. 705-707XXXX (W,T) only

	D3	D4	D5	D6	D7	D14	D30	R39	J7, C45 R23,24	IC6, TP9, VR2 C29-35, R32-36
-11	O	O	X	X	X	O	X	X	O	X
-21	O	X	X	X	X	O	X	X	O	X
-51	X	O	O	O	O	X	O	O	X	O
-61	X	X	X	O	O	X	O	O	X	O

O : Used X : Not used

LCD ASS'Y (W02-037X-05)

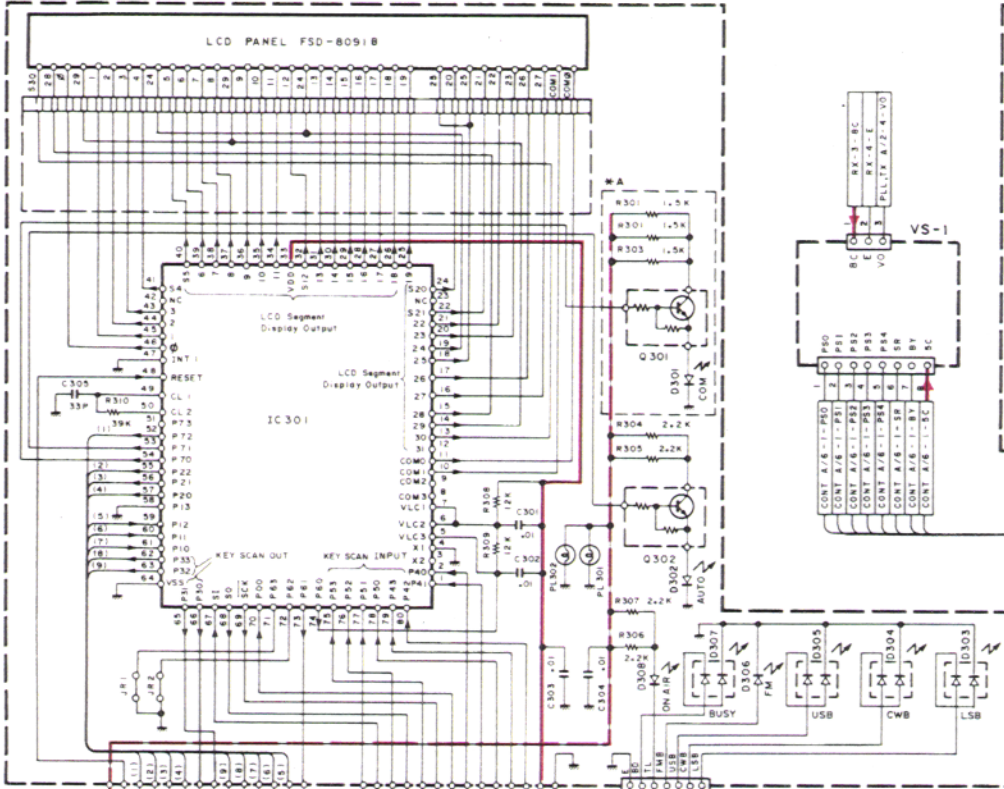

NO.	A
W02-0376-05	YES
W02-0377-05	NO

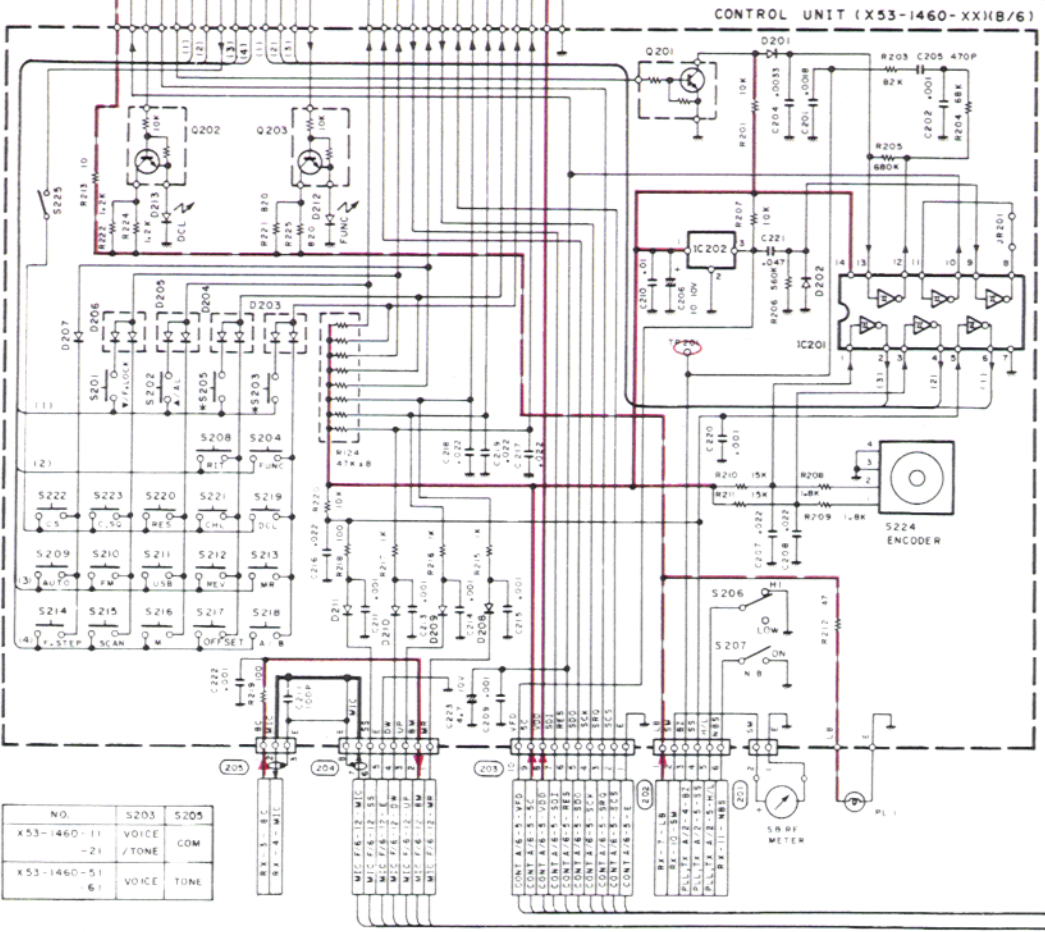
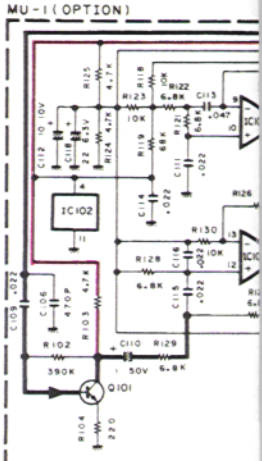

NO.	S203	S205
X53-1460-11	VOICE	COM
-21	/TONE	
X53-1460-51	VOICE	TUNE
61		

PLT.X 8/2-10-OP	12
PLT.X 8/2-10-CP	11
PLT.X 8/2-10-1A	10
PLT.X 8/2-10-1B	9
VS-1-1-SC	8
VS-1-1-SR	7
VS-1-1-PS4	6
VS-1-1-PS3	5
VS-1-1-PS2	4
VS-1-1-PS1	3
VS-1-1-PS0	2
VS-1-1-PS0	1

RX-2-RD	8
RX-4-YO	7
RX-4-ME	6
RX-3-SC	5
RX-5-SB	4
SOL/AF-9-SB	3

CONT 8/6-203-VFD	10
CONT 8/6-203-V2	9
CONT 8/6-203-V00	8
CONT 8/6-203-S01	7
CONT 8/6-203-RES	6
CONT 8/6-203-S00	5
CONT 8/6-203-S04	4
CONT 8/6-203-S00	3
CONT 8/6-203-E	2
CONT 8/6-203-E	1

CONT 8/6-204-ME	10
CONT 8/6-204-BM	9
CONT 8/6-204-UP	8
CONT 8/6-204-DW	7
CONT 8/6-204-E	6
CONT 8/6-204-SIC	5

CIRCUIT DIAGRAM TR-751A/E

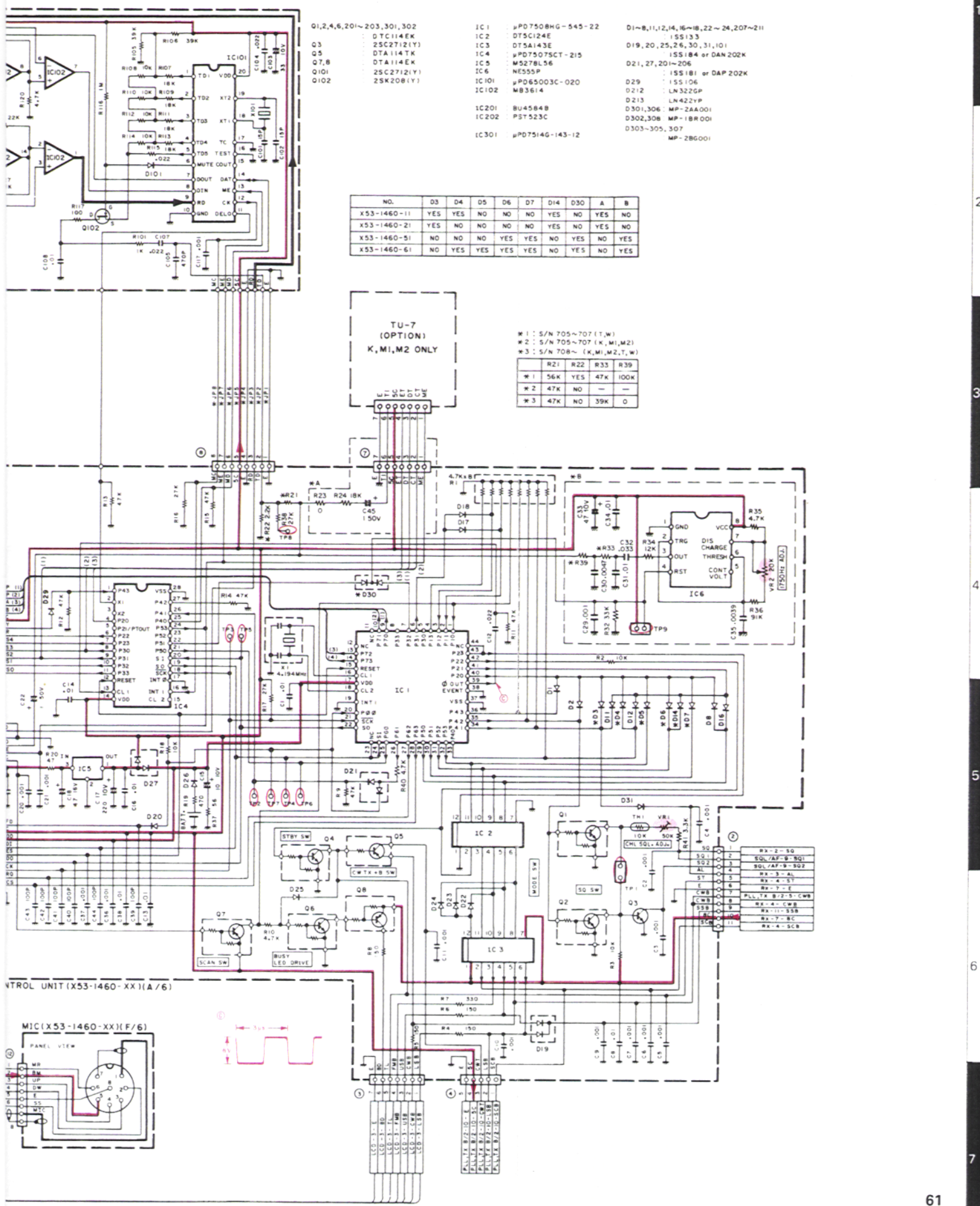

Q1,2,4,6,201~203,301,302
 Q3 : DTC114EK
 Q5 : 25C2712(Y)
 Q7,8 : DTA114TK
 Q10 : 25C2712(Y)
 Q102 : 25K208(Y)

IC1 : μ PD7508HG-545-22
 IC2 : DT5C124E
 IC3 : DT5A143E
 IC4 : μ PD75075CT-215
 IC5 : DTA114EK
 IC6 : NE555P
 IC101 : μ P065003C-020
 IC102 : MB3614
 IC201 : BU4584B
 IC202 : PST523C
 IC301 : μ PD7514G-143-12

D1~8,11,12,14,16~18,22~24,207~211 : 1S5133
 D19,20,25,26,30,31,101 : 1S5184 or DAN202K
 D21,27,201~206 : 1S5181 or DAP202K
 D29 : 1S5106
 D212 : LN422P
 D213 : LN422P
 D301,306 : MP-2AA-001
 D302,308 : MP-1BR-001
 D303~305,307 : MP-2BG-001

NO.	D3	D4	D5	D6	D7	D14	D30	A	B
X53-1460-11	YES	YES	NO	NO	NO	YES	NO	YES	NO
X53-1460-21	YES	NO	NO	NO	NO	YES	NO	YES	NO
X53-1460-51	NO	NO	NO	YES	YES	NO	YES	NO	YES
X53-1460-61	NO	YES	YES	YES	YES	NO	YES	NO	YES

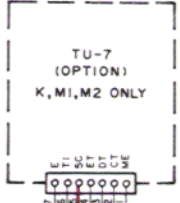

*1 : S/N 705~707 (T,W)
 *2 : S/N 705~707 (K,M1,M2)
 *3 : S/N 708~ (K,M1,M2,T,W)

	R21	R22	R33	R39
*1	56K	YES	47K	100K
*2	47K	NO	—	—
*3	47K	NO	39K	0

CONTROL UNIT (X53-1460-XX)(A/6)

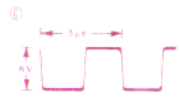
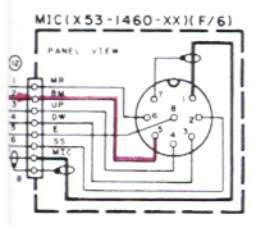

1	RX-3-SG
2	SQL/AF-9-SQ1
3	SQL/AF-9-SQ2
4	ST
5	RX-4-S-T
6	RX-5-T
7	PLL TX B/2-5-CWB
8	RX-4-CWB
9	RX-11-SSB
10	RX-7-RC
11	RX-4-SCR

2
3
4
5
6
7

TR-751A/E PC BOARD VIEWS

SUB VCO (X58-1000-XX) -00 : W,T -11 : K,M1,M2
Component side view

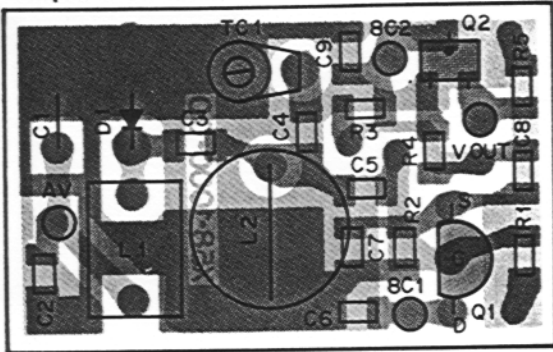

Q1 : 2SK125 Q2 : 2SC2714(Y)
D1 : 1SV50

SQUELCH SWITCH (X59-1120-00)
Component side view

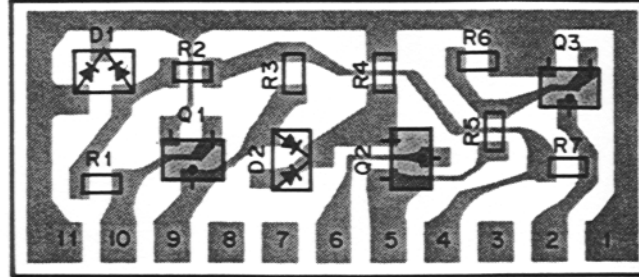

Q1-3 : 2SC2712(Y)
D1,2 : 1SS184 or DAN202K

FM MIC AMP (X59-1090-00) Component side view
S/No. 705-707XXXX : W,T

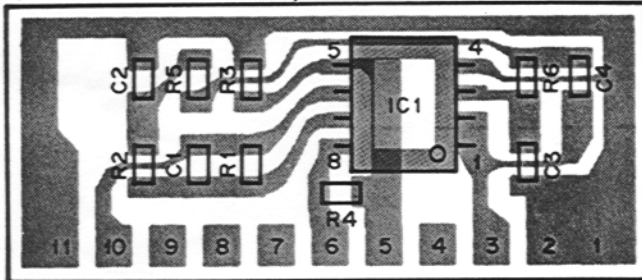

IC1 : NJM4558M

CW BREAK IN (X59-1130-00)
Component side view

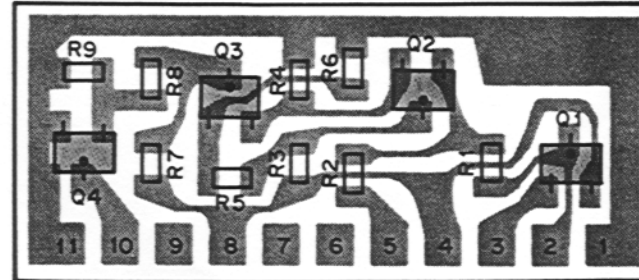

Q1 : DTA114EK Q2-4 : 2SC2712(Y)

-6V DC-DC (X59-1100-00)
Component side view

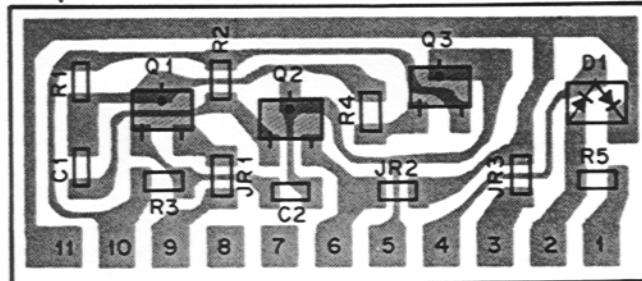

Q1,2 : 2SC2712(Y) Q3 : 2SA1162(Y)
D1 : 1SS226

FM MIC AMP (X59-3000-00) Component side view
S/No. 705-707XXXX : K,M1,M2

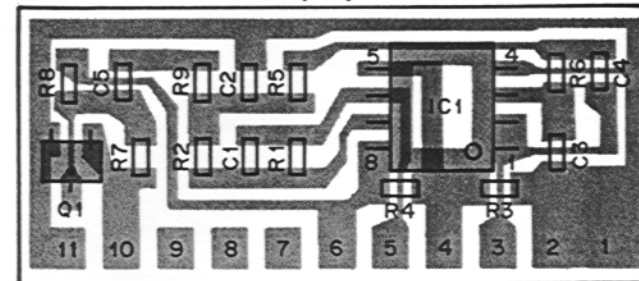

Q1 : 2SC2712(Y) IC1 : NJM4558M

AF PRE AMP (X59-1110-00)
Component side view

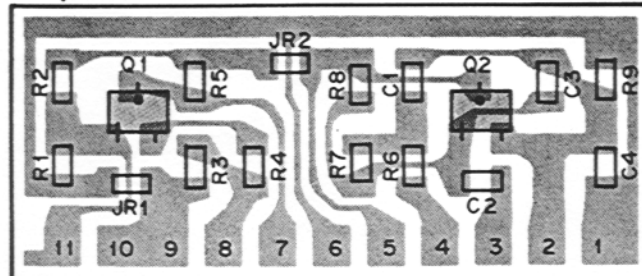

Q1,2 : 2SC2712(Y)

FM MIC AMP (X59-3000-01) Component side view
S/No. 708XXXX- : K,M1,M2,W,T

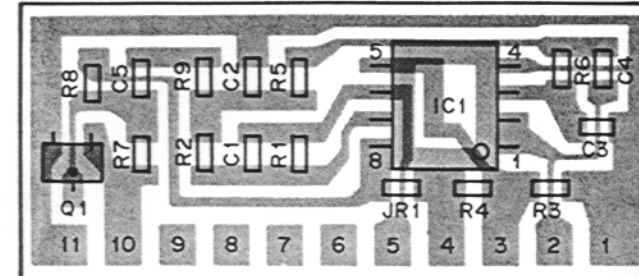

Q1 : 2SC2712(Y) IC1 : NJM4558M

FINAL UNIT (X45-1490-11) Component side view

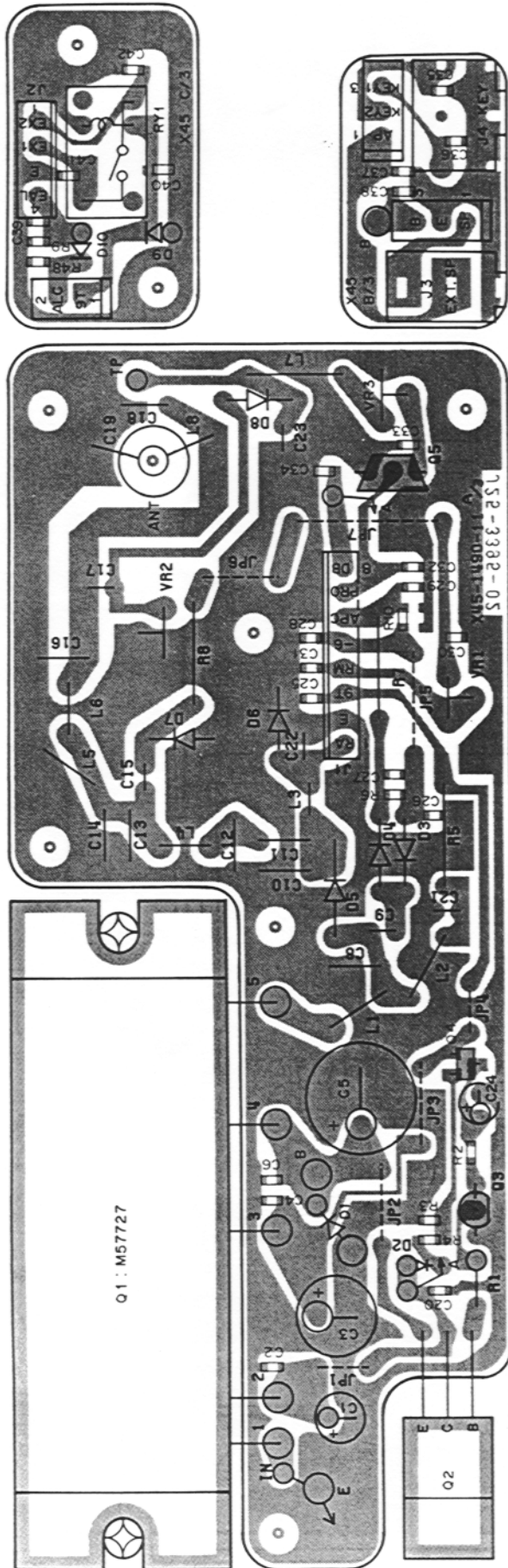

Q1 : M57727 Q2 : 2SA1307(Y) Q3 : 2SC1815(Y) Q4 : 2SA1162(Y) O5 : 2SC2458(Y)
 D1 : U15B D2,7,8 : 1S1587 D3,4 : 1SS101 D5 : M1407 D6 : M1308 D9 : 1SS133 D10 : MTZ6.2JA

FINAL UNIT (X45-1490-11) Foil side view

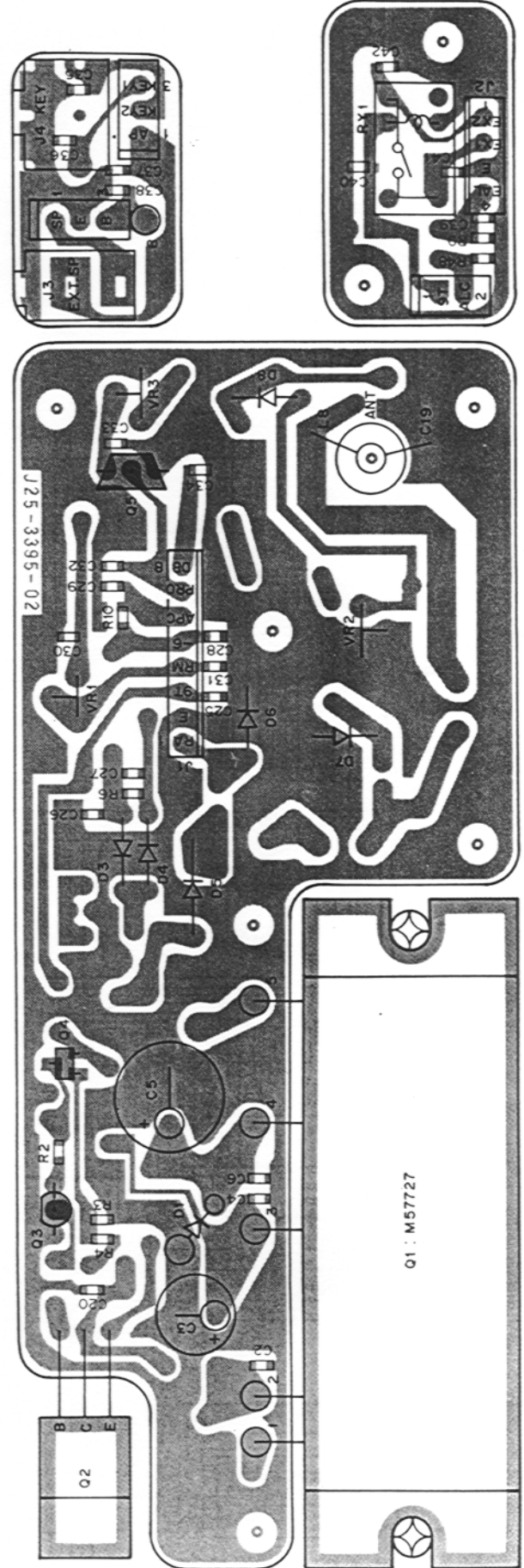

Q1 : M57727

COMPOSITE UNIT (PLL, TX) (X60-1310-XX) -11 : K,M1,M2 -01 : W,T
 Component side view

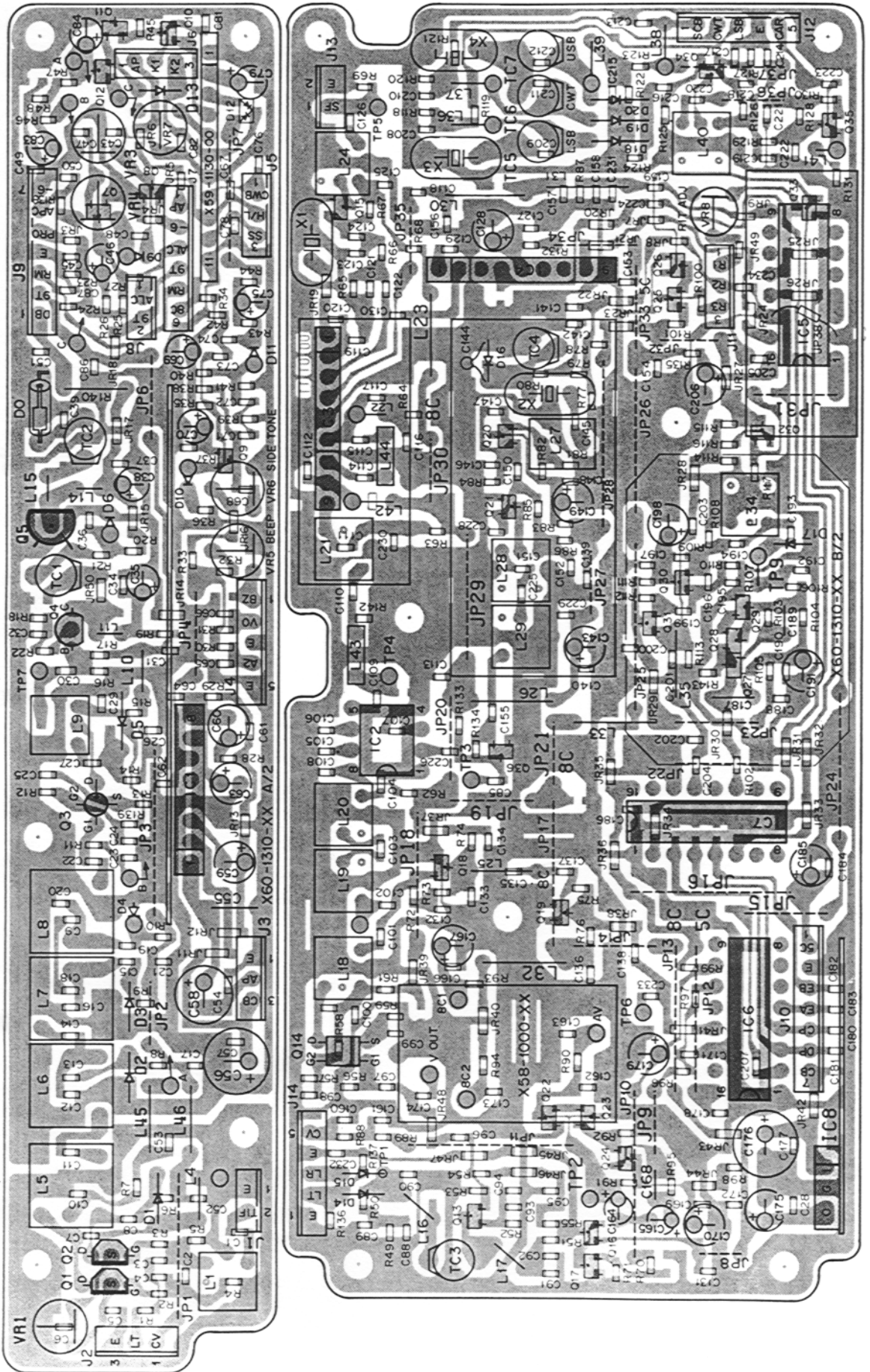

Q1,2 : 2SK161(GR) Q3 : 3SK74(L) Q4 : 2SC2026 Q5 : 2SC2538-22-A Q7,9,15,17,32 : 2SC2712(Y) Q8 : DTC143EK Q10,12,16,25 : DTA143EK
 Q11 : 2SA1162(Y) Q13,18,19,21,30,31,34-36 : 2SC2714(Y) Q14 : 3SK73(GR) Q20 : 2SC2715(Y) Q22-24,27-29 : 2SC3324(G,B) Q26,33 : DTC144EK
 IC1 : MB3712 IC2 : SN16913P IC3 : TA7310P IC4 : TC5082P-G IC5 : TC74H390P IC6,7 : TC9172P IC8 : L78N08

PC BOARD VIEWS TR-751A/E

COMPOSITE UNIT (PLL, TX) (X60-1310-XX) -11 : K,M1,M2 -01 : W,T

Foil side view

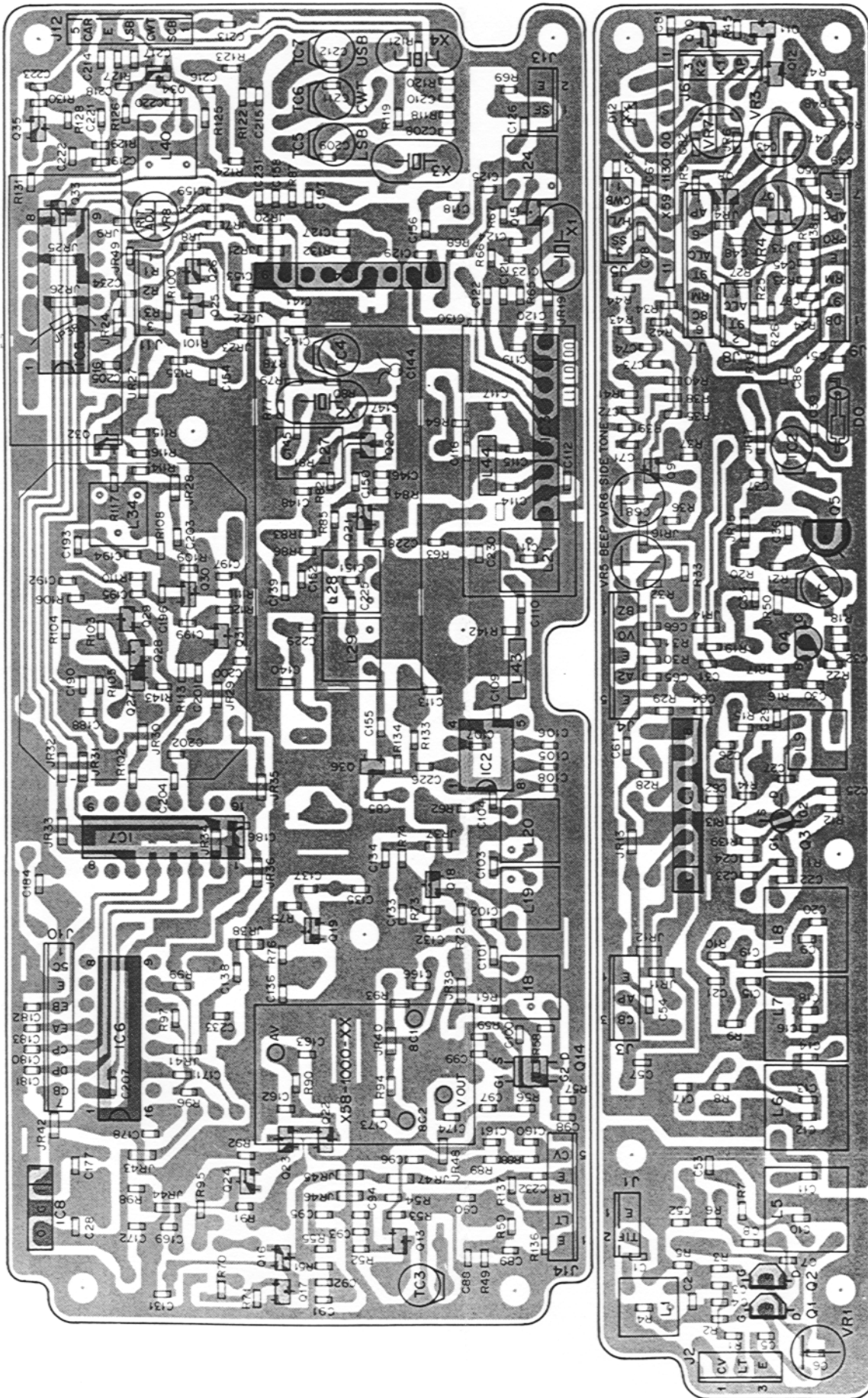

1
2
3
4
5
6
7

D1-5: B8221 D6,10,11,13: ISS133 D9: IN60A DT2: DAINZOK OF ISS184 U14,15,18-20: MA880 U10,17: ISV1D3

TR-751A/E PC BOARD VIEWS

COMPOSITE UNIT (RX) (X60-1320-00) S/No. 705-707XXXX : W,T
Component side view

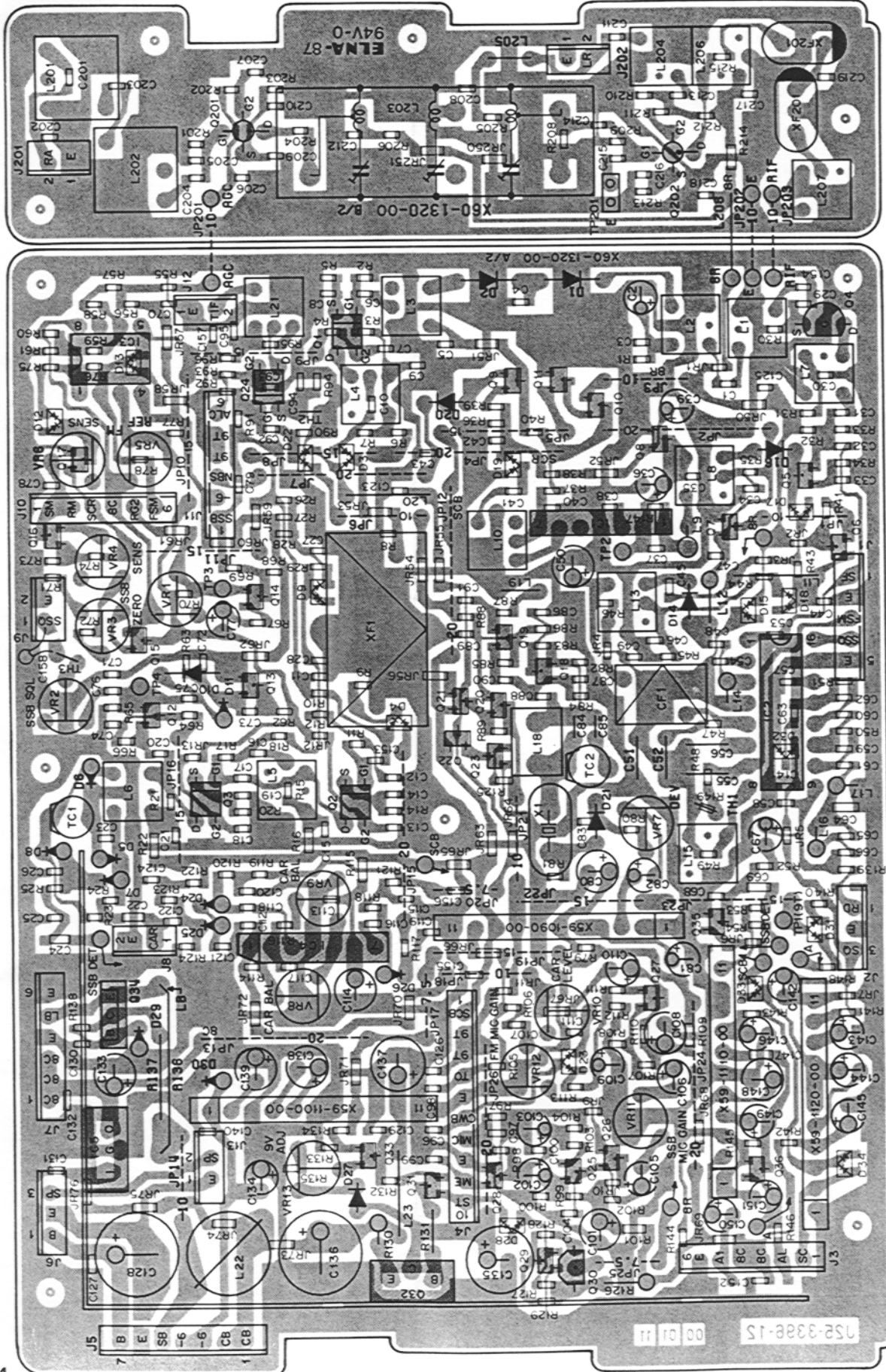

- Q1-3,24 : 3SK73(GR) Q4 : 2SK125 Q5,18,19 : 2SC2714(Y) Q6,8,9,12,13,20,31,36 : 2SC2712(Y) Q7,11,17,21,23,28,29,35 : DTC114EK Q10,22 : DTA114EK
- Q14,15 : 2SK208(O) Q16,33 : 2SA1162(Y) Q25-27 : 2SC3324(G,B) Q30 : 2SA1115(E) Q32 : 2SA1307(Y) Q34 : 2SC3419(Y) Q201 : 3SK129(Q,R) Q202 : 3SK74(L)
- IC1 : TA7302P IC2 : TA7761P IC3 : NJM4558D or μ PC4558 IC4 : AN612 IC5 : μ PC78M08H
- D1,2,26 : 1S1587 D3,4,12,13,15,22,33,34 : 1SS184 or DAN202K D5-8 : 1N60A D9,17,18,23,28,31 : 1SS181 or DAP202K D10,11 : 1SS106 D14,16,20 : 1SS133 D19,32 : 1SS226
- D21 : 1S2208 D24,25 : BA282 D27 : VD1223 D29 : MTZ11JC D30 : MTZ6.2JA

COMPOSITE UNIT (RX) (X60-1320-00) S/No. 705-707XXXX : W,T
 Foil side view

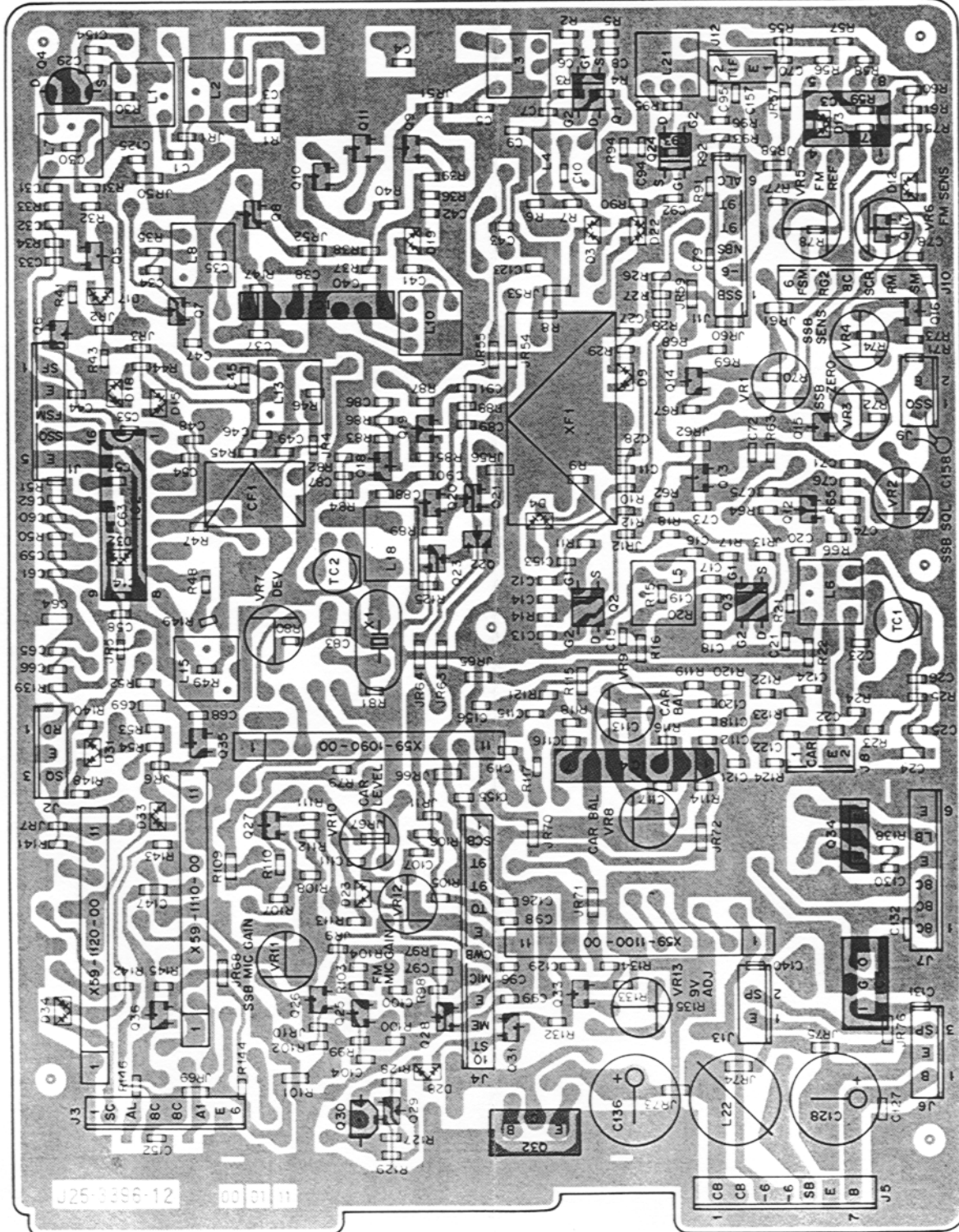
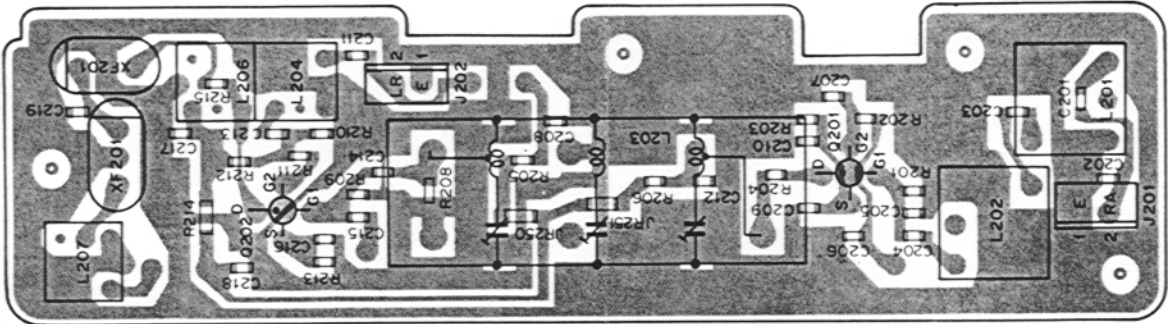

J25 3356-12

1 CB
 2 CB
 3 -6
 4 -6
 5 SB
 6 E
 7 B
 J5

COMPOSITE UNIT (RX) (X60-1320-XX) Foil side view
 -00 : W,T -11 : K,M1,M2 S/No. 708XXXX- : K,M1,M2,W,T

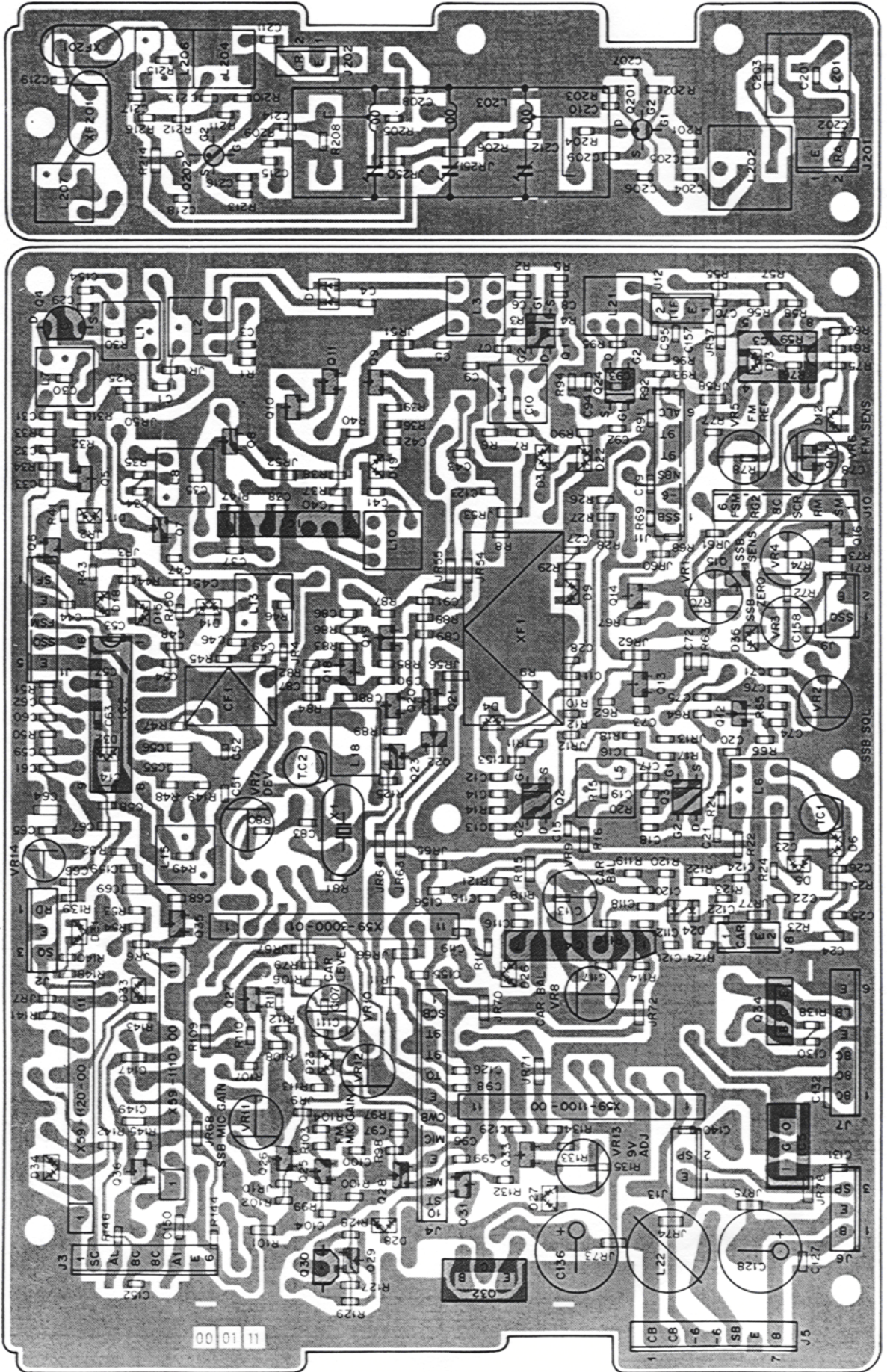

PC BOARD VIEWS TR-751A/E

COMPOSITE UNIT (RX) (X60-1320-11) S/No. 705-707XXXX : K,M1,M2

Component side view

Foil side view

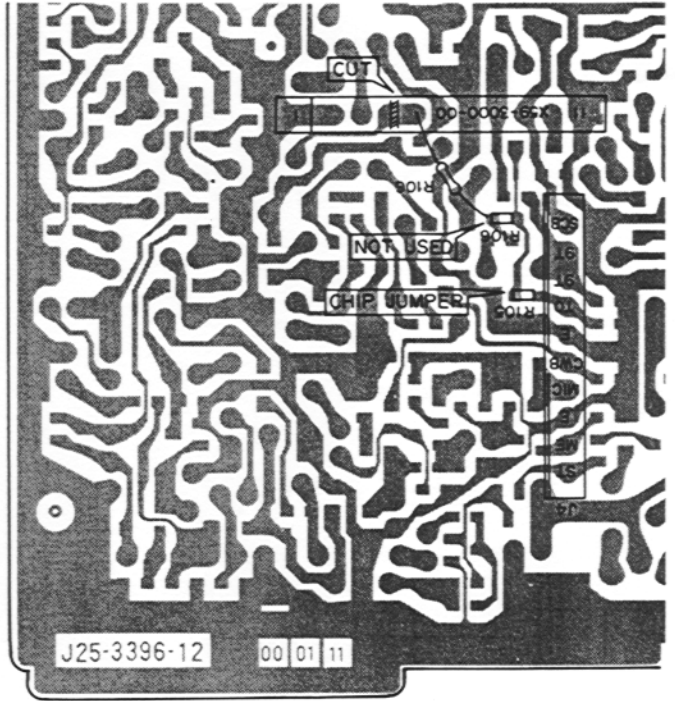
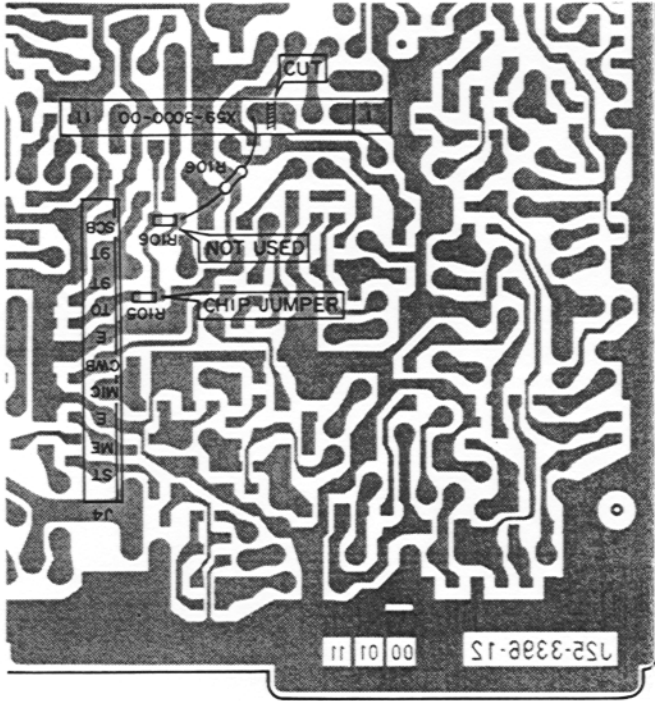

2SC1815

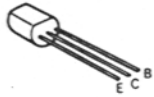

2SC2538-22-A

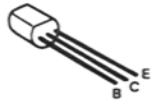

2SC2026

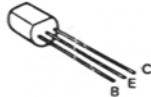

2SA1115
2SC2548

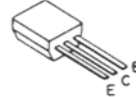

2SA1307

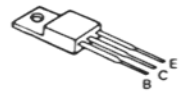

2SA1162
2SC2712
2SC2714
2SC2715
2SC3324



2SC3419

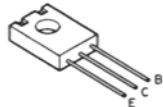

DTA114EK
DTA114TK
DTA143EK



DTC114EK
DTC143EK
DTC144EK

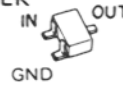

2SK125

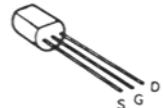

2SK161



2SK208



3SK73

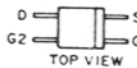

3SK74
3SK129

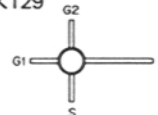

M5278L56
PST523C

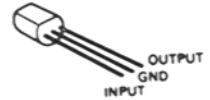

MB3712

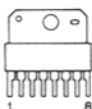

TA7310P
TC5082P-G

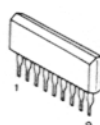

L78N08

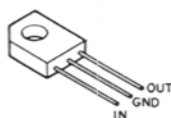

AN612
TA7302P



μPC78M08H

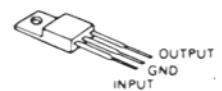

TR-751A

Signal line

Control line

Control line

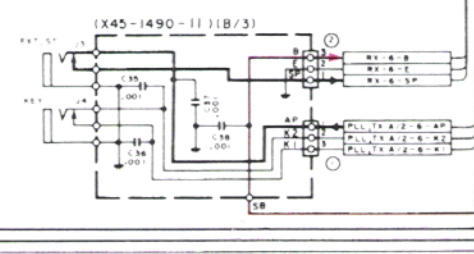
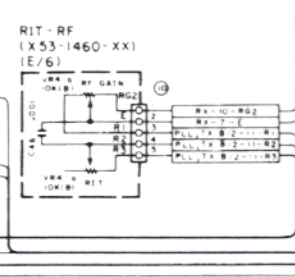
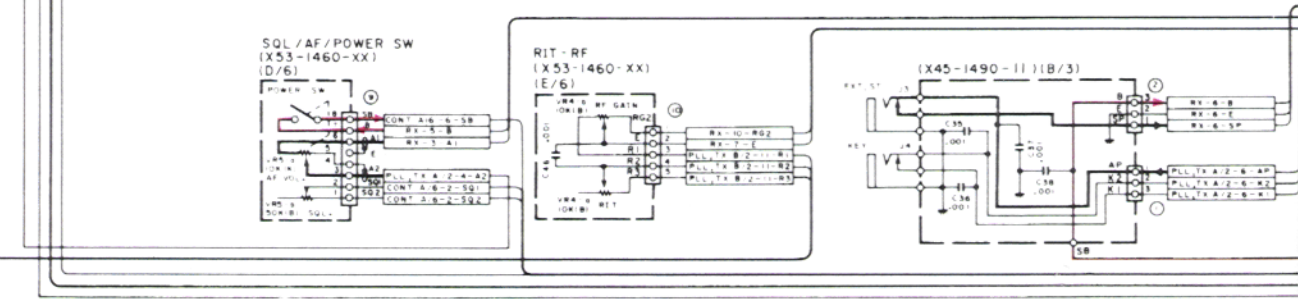
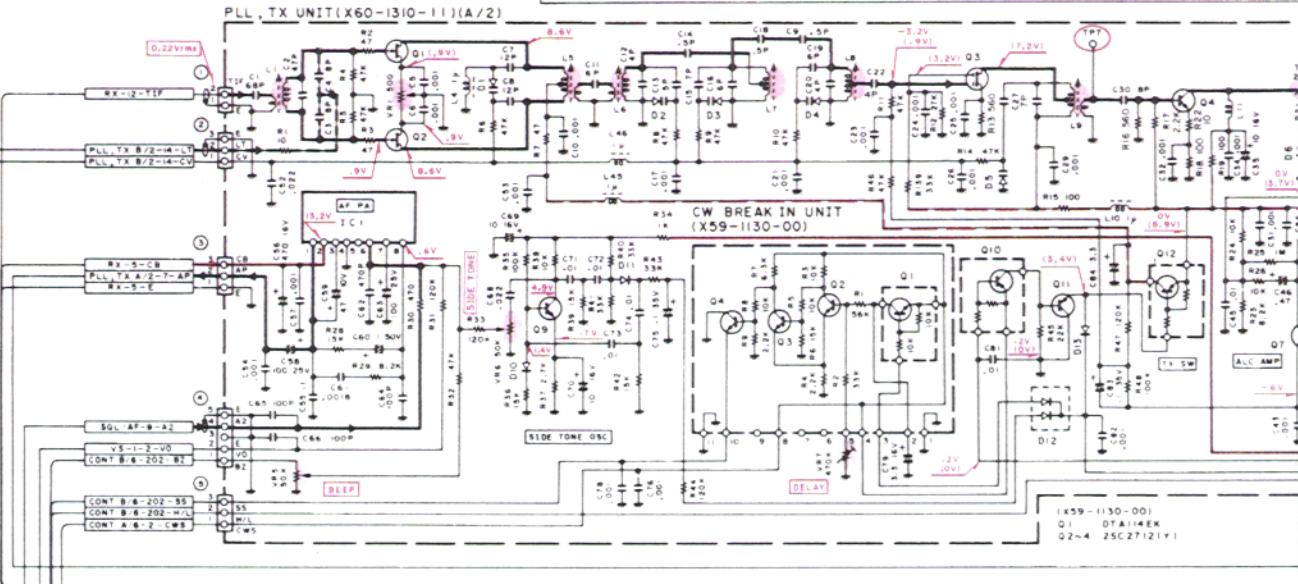
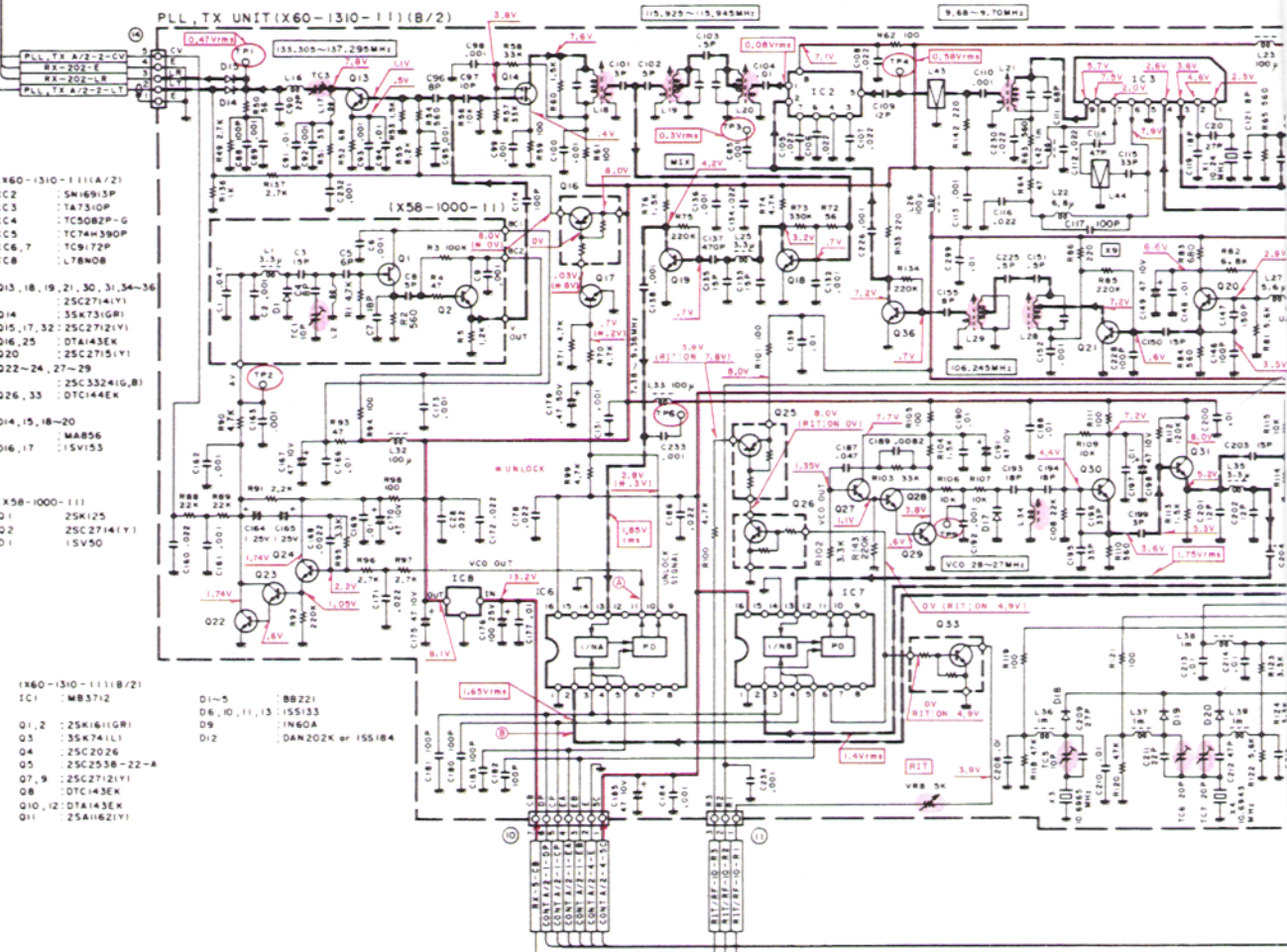

2

3

4

5

6

7

ion DC line - - - - - DB, 9T Line

SCHEMATIC DIAGRAM

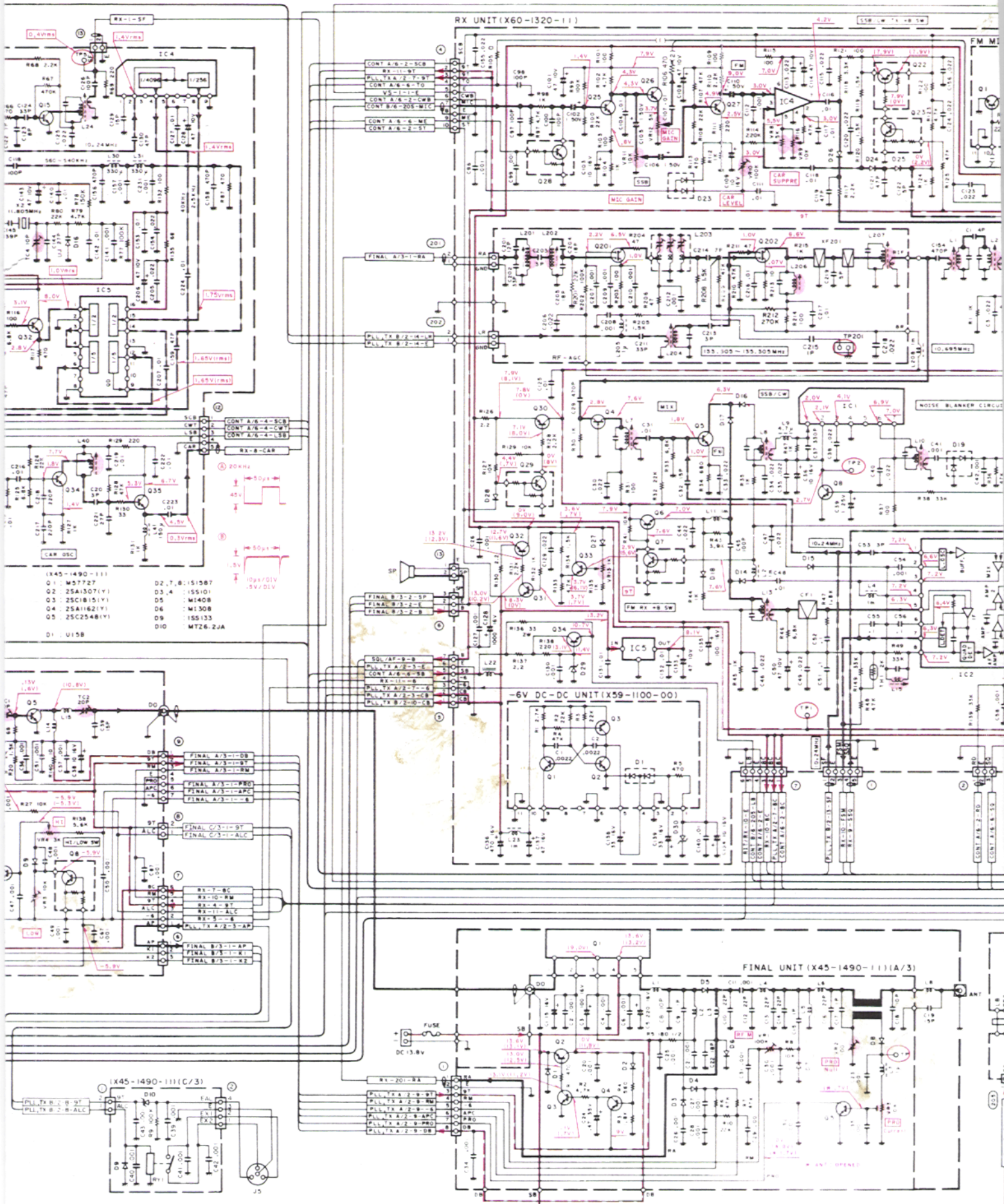

Voltage measurement conditions $f=144.00\text{MHz}$, RX no signal, () : TX.

S/No. 705-707XXX : K,M1,M2

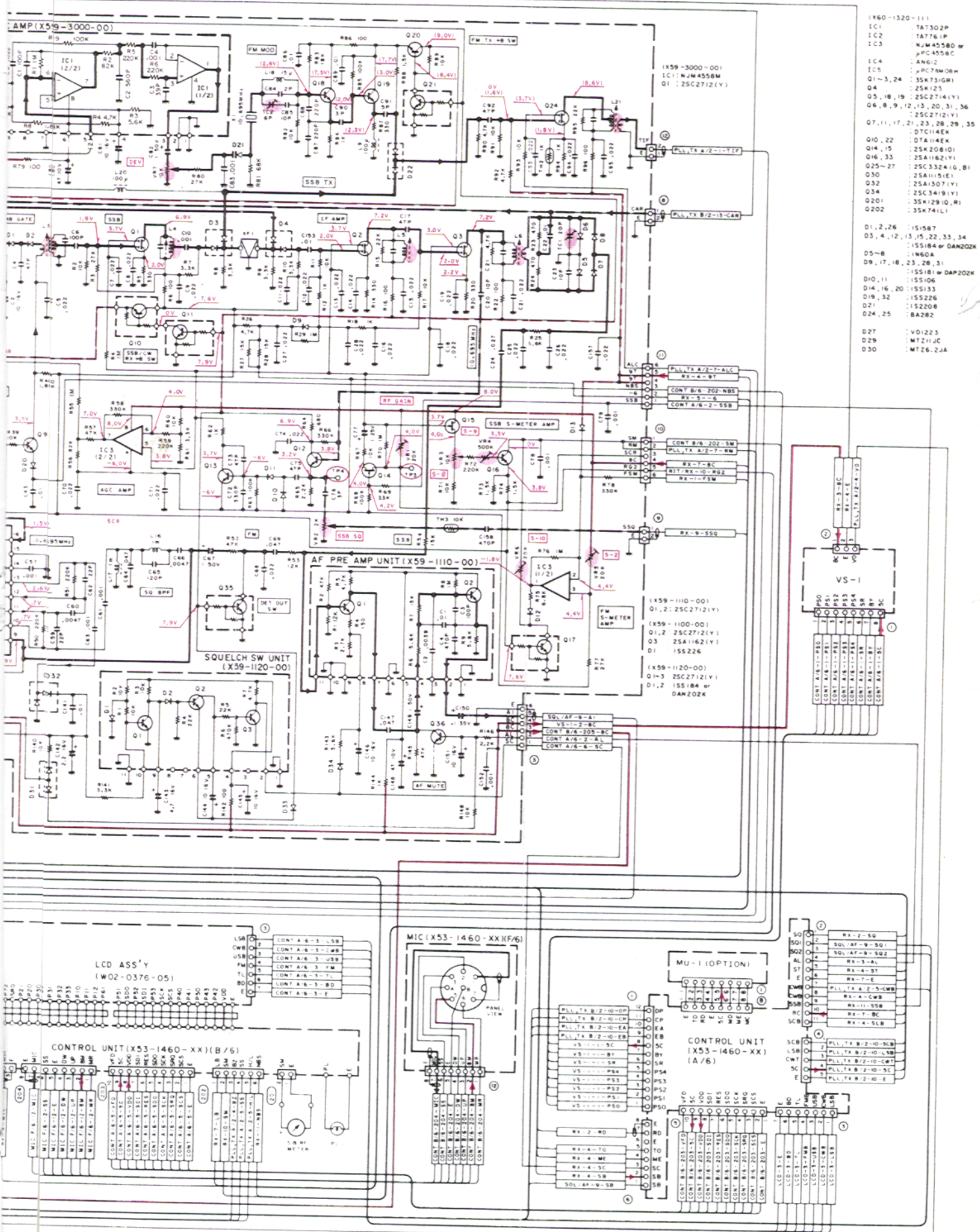

- (K60-1320-111)
- IC1 : TA7302P
- IC2 : TA7761P
- IC3 : NJM4558B or $\mu\text{PC4558C}$
- IC4 : AN612
- IC5 : $\mu\text{PC73M08W}$
- Q1-3,24 : 55K731GR1
- Q4 : 2SK125
- Q5,18,19 : 2SC2714(Y)
- Q6,8,9,12,13,20,31,36 : 2SC2712(Y)
- Q7,11,17,21,23,28,29,35 : DTC14EX
- Q10,22 : DTA14EX
- Q14,15 : 2SK208(D)
- Q16,33 : 2SA1162(Y)
- Q25-27 : 2SC3324(G,B)
- Q30 : 2SA115(E)
- Q32 : 2SA1307(Y)
- Q34 : 2SC3419(Y)
- Q201 : 3SK129(IQ,R)
- Q202 : 3SK74(L)
- D1,2,26 : 55S187
- D3,4,12,13,15,23,33,34 : 55S184 or DAN202K
- D5-8 : 1N60A
- D9,17,18,23,28,31 : 55S181 or DAP202K
- D10,11 : 55S181 or DAP202K
- D14,16,20 : 55S133
- D19,32 : 55S226
- D21 : 55S208
- D24,25 : 8A2B2
- D27 : VD1223
- D29 : MT211JC
- D30 : MT26.2JA

COMPOSITE UNIT (RX) (X60-1320-XX) Component side view
 -00 : W,T -11 : K,M1,M2 S/No. 708XXX - : K,M1,M2,W,T

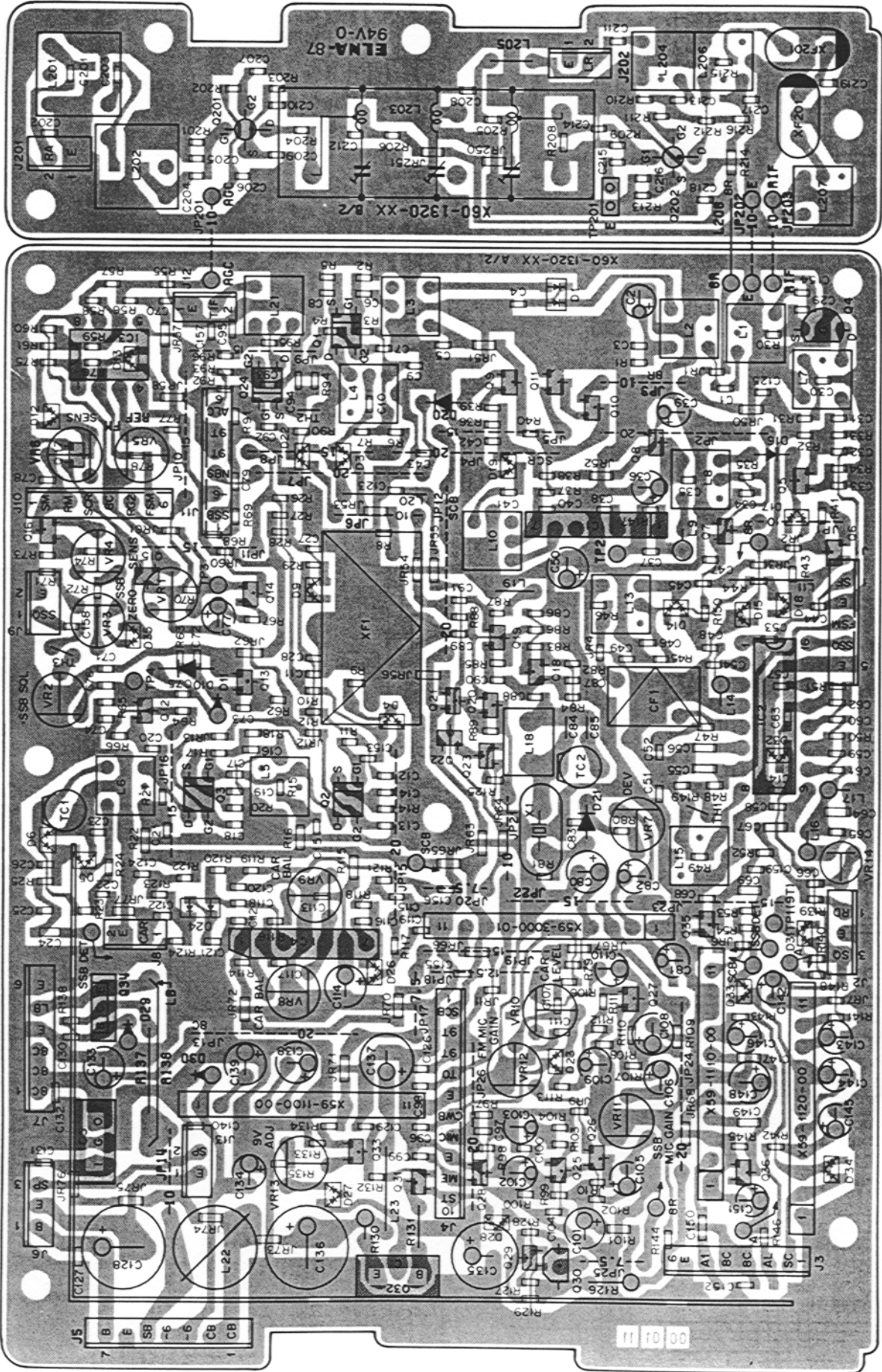

- O1-3,24 : 3SK73(GR) O4 : 2SK125 O5,18,19 : 2SC2714(Y) O6,8,9,12,13,20,31,36 : 2SC2712(Y) O7,11,17,21,23,28,29,35 : DTC114EK O10,22 : DTA114EK
- Q14,15 : 2SK208(O) Q16,33 : 2SA1162(Y) Q25-27 : 2SC3324(G,B) Q30 : 2SA1115(E) Q32 : 2SA1307(Y) Q34 : 2SC3419(Y) Q201 : 3SK129(O,R) Q202 : 3SK74(L)
- IC1 : TA7302P IC2 : TA7761P IC3 : NJM4558D or μ PC4558C IC4 : AN612 IC5 : μ PC78M08H
- D1,24 : 1SS272 D3,4,12-15,17,22,26,33,34 : 1SS184 D5,6,32 : HSM88AS D9,18,23,28,31,35 : 1SS181 D10,11 : 1SS106 D19,27 : 1SS226 D16,20 : 1SS133
- D21 : 1SS2208 D29 : MT211JC D30 : MT26.2JA

TR-751E

Signal line

Control line

Common

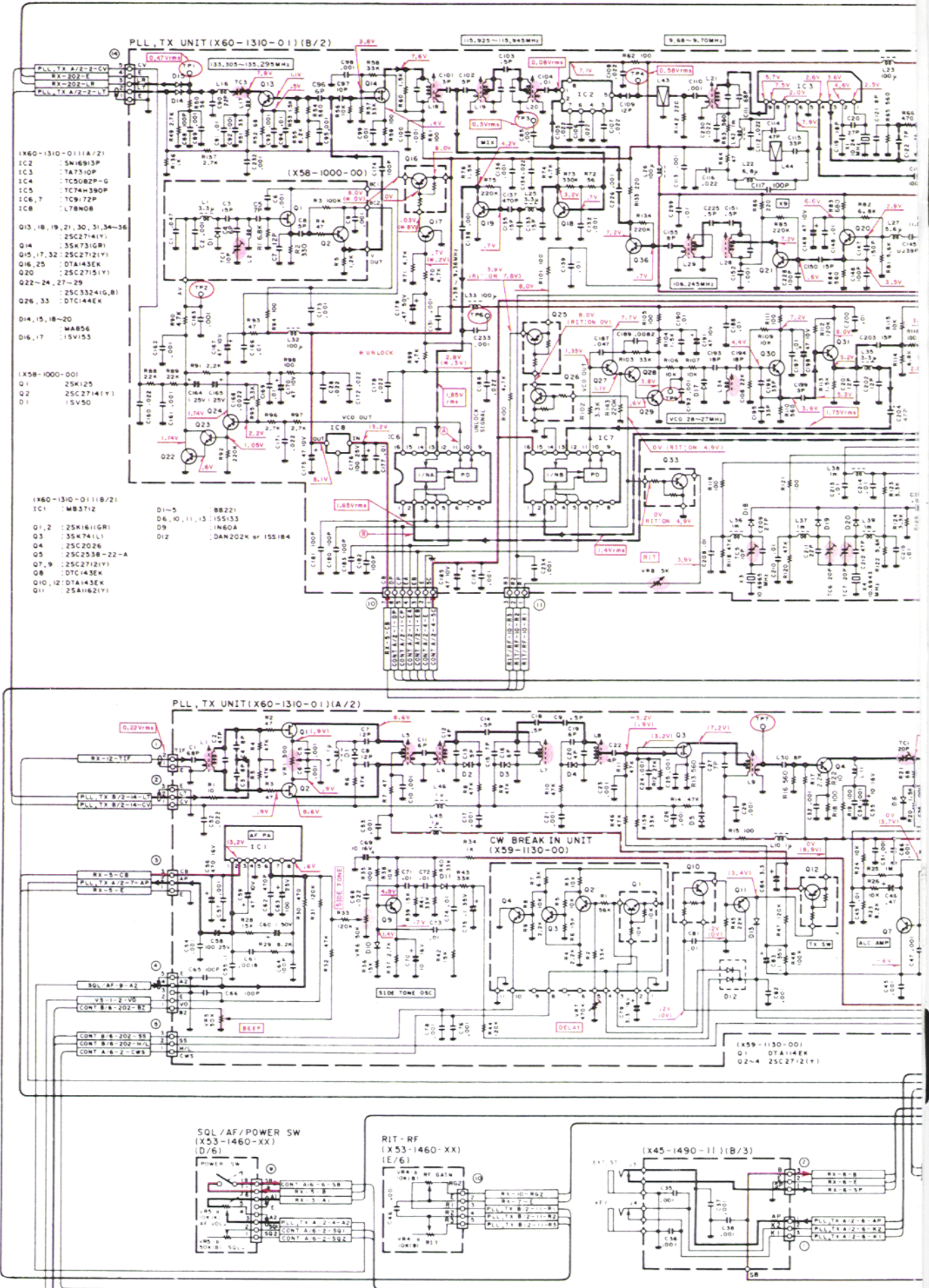

DC line --- DB, 9T Line

SCHEMATIC DIAGRAM

